 Salehi: Trump under 'illusion' about nuclear deal **2**

 Total's deal 'breaks the ice', Iran says **4**

 Kalantari appointed new environment chief **12**

 Iran book ticket for 2018 Men's World Championships **15**

Majlis approves bill to counter U.S.



Saudi prince seeks Iraqi mediation with Iran: Iraqi minister

POLITICS TEHRAN — Iraqi Interior Minister Qasim al-Araji announced on Sunday that Saudi Crown Prince Mohammed bin Salman (MBS) has officially asked him to mediate between Tehran and Riyadh whose relations have nosedived over certain issues.

"Mohammed bin Salman officially conveyed his request to me that Iraq mediates between Iran and Saudi Arabia to ease tensions," al-Araji told reporters in Tehran following a meeting with his Iranian counterpart Abdolreza

Rahmani Fazli. "Previously King Salman had made the same request," the minister added. Tehran has not yet reacted to the news.

"We believe friendly relations between Iran and Saudi Arabia contributes to the security of the region," the Iraqi minister noted.

The news come after Iran's Foreign Minister Mohammad Javad Zarif and his Saudi counterpart Adel al-Jubeir shook hands on the sidelines of an OIC emergency meeting in Istanbul on August 2. **→13**

"The Salesman" crowned best film at Hafez Awards

A R T TEHRAN — Asghar Farhadi's Oscar-winning drama "The Salesman" has been named best film at the 17th Hafez Awards, Iran's first and only private awards in the film industry and TV productions.

The Hafez Awards were presented at the Grand Hall of the Interior Ministry in Tehran on Saturday night as all winners commemorated Ali Moallem, the founder of the awards who died of a heart attack in March.

Moallem's colleagues in his Persian cinematic monthly Donya-ye Tasvir, which is the organizer of the Hafez Awards, and his family launched a new prize in memory of Moallem this year.

This award is presented to a person representing an outstanding national

achievement. The first one went to Asghar Farhadi who could not attend the awards ceremony. However, he talked to the audience through a video at the ceremony.

Farhadi remembered Moallem and thanked his family for their efforts to keep the awards alive after the death of Moallem in the video.

The award for best director was presented to Mohammad-Hossein Mahdavian for his acclaimed political drama "The Middy Event".

Three awards were presented in the best actor category. Javad Ezzati for "The Middy Event", Shahab Hosseini for "The Salesman", and Navid Mohammadzadeh for "Lanturi" received the awards. **→16**

پر شیا خودرو
فروش و خدمات BMW در ایران

دنيا مبهوت انتخاب شماست.

THE NEXT 100 YEARS

MEDIA HIGHLIGHTS



Top commander to visit Turkey to discuss terrorism

POLITICS TEHRAN — The chief of staff of the Iranian armed forces is scheduled to visit Turkey on Tuesday for talks on fight against terrorism, IRIB reported on Sunday.

The three-day tour by Major General Mohammad Baqeri will take place at the official invitation by his Turkish counterpart General Hulusi Akar.

According to the report, Baqeri and his high-ranking company are expected to discuss the latest regional developments, bilateral cooperation and border issues with Turkish officials.



Parliament eases drug death penalty

POLITICS TEHRAN — Iran's parliament passed a long-awaited amendment to its drug trafficking laws on Sunday, raising the thresholds that can trigger capital punishment.

The bill must still be approved by the Guardian Council but gained parliamentary approval after months of debate.

The new law raises the amounts that can trigger the death penalty from 30 grams to two kilos for the production and distribution of chemical substances such as heroin, cocaine and amphetamines.

For natural substances such as opium and marijuana, the levels have been raised from five to 50 kilos.



Navy to dispatch forces to West Atlantic

POLITICS TEHRAN — The Iranian Navy commander has highlighted his forces' powerful presence in international waters, announcing the Navy's fleets are planned to be dispatched to the west of the Atlantic Ocean in the near future.

Speaking at a ceremony on Sunday to unveil new books by the Navy commanders, Rear Admiral Habibollah Sayyari referred to attempts by Western media outlets to portray the Iranian Navy as weak, saying the Iranian naval forces have proven them wrong, Press TV reported.



'Science Ministry to be provided with caretaker'

POLITICS TEHRAN — The Ministry of Science will be provided with a caretaker before a minister is introduced and approved, minister of ICT told reporters on Sunday on the sidelines of a cabinet meeting.

He also said none of the proposed ministers for the second administration have been forced upon President Rouhani, ISNA reported.

"Rouhani stands behind every one of the proposed ministers," Vaezi stressed, rejecting allegations that the president is not wholeheartedly supportive of some of them.

Rouhani's cabinet held its last session on Sunday. The new cabinet in his second administration will begin work after a confirmation by Majlis.



JCPOA violation to have 'dire' consequences: Russian professor

POLITICS TEHRAN — Vitaly Naumkin, the head of the Centre for Arab Studies of the Russian Academy of Sciences' Institute of Oriental Studies, has said the consequences of a potential move by the U.S. to renege on its commitments to the JCPOA will be 'dire'.

"I think it is detrimental to the interests of the United States itself because we know that the JCPOA is an important achievement of the international community," Naumkin, also an adviser to UN envoy Staffan de Mistura, told Tasnim in an interview published on Sunday.



IRGC officer killed in Syria

POLITICS TEHRAN — A military officer from the Islamic Revolution Guards Corps has been killed in a recent clash with Daesh in Syria, the Young Journalists Club reported on Sunday.

Colonel Janmohammad Alipour is the second member of the Revolution Guards who has been killed in Syria over the past week.

According to the report, the slain colonel was from the southwestern city of Andimeshk, Khuzestan province. He had fought Daesh long in Syria.

Salehi: Trump under 'illusion' about nuclear deal

By Hadi Haghshenas

TEHRAN — The U.S. president is hallucinating about the international nuclear deal, Iran's nuclear chief said on Sunday, a few days after Donald Trump claimed Iran was not in compliance.

"Trump is living in illusion," Ali Akbar Salehi, who was re-appointed as nuclear chief on Thursday, told reporters when asked what he thought about the recent remarks by Trump about Tehran's commitments to the deal.

Formally known as the Joint Comprehensive Plan of Action (JCPOA), the deal was forged in July 2015 between Iran, the U.S., Russia, China, Germany, France and England. It gave Iran relief from all nuclear-related sanctions in exchange for rolling back its nuclear activities.

On Thursday, Trump reiterated his claim that Iran is not "living up to the spirit" of the nuclear accord which he called a "horrible agreement."

"I don't think they're living up to the spirit of the agreement," Trump told reporters at his golf retreat in New Jersey, where he is on a 17-day working vacation. "I personally don't think they're in compliance. But we have time, and we're going to see."

He added, "I think you'll see some very strong things taking place if they don't get themselves in compliance."

The Trump administration has taken a hard line against Tehran since its inaugu-



ration in January, seeking to mar the deal, which Barack Obama hailed as his signature foreign policy achievement.

As demanded by the U.S. law, Trump has so far certified Iran's compliance with the JCPOA twice though he did it in July reluctantly. A third certification is due in October, a real test for Washington's commitment to a multilateral agreement endorsed by the UN Security Council (UNSC) Resolution 2231.

Reacting to Trump, Iran's Foreign Minister Mohammad Javad Zarif tweeted on Friday: "POTUS always wanted to kill JCPOA. To avoid isolation, he's trying to blame it on Iran. Bad faith on top of US violating the letter & spirit"

Unlike Washington, the other JCPOA signatories and the UNSC have not found Tehran in default.

clear deal should know that they would also tear apart their political life," Rouhani emphasized, accusing the "unreliable partner" U.S. of a "lack of commitment" to the deal.

Tehran says Washington keeps ignoring the terms of the deal, particularly citing paragraphs from the JCPOA which explicitly demands the U.S. to "make best efforts in good faith to sustain this JCPOA and to prevent interference with the realization of the full benefit by Iran of the sanctions lifting."

Iran also says new sanctions by Washington is undermining the nuclear deal. Trump signed into law on August 3 a piece of legislation that levied new sanctions against Iran, Russia and North Korea.

The Iranian portion of the bill seeks to ban anyone dealing with Iran's ballistic missile program from entering the U.S., and blocks transactions on properties held in the U.S. by people associated with the program, the CNN reported.

"The main purpose of the United States in implementing the sanctions against Iran is to destroy the JCPOA," said Abbas Araghchi, Iran's deputy foreign minister who acted as a top negotiator in the nuclear talks.

Tehran promised retaliation though trade between the two sides is meager and there are no diplomatic relations for decades now.

On Sunday, 240 Iranian lawmakers overwhelmingly passed a retaliatory bill to pour approximately \$260 million more each into the country's ballistic missile program and the Quds Force, the external wing of the Islamic Revolution Guards Corps (IRGC), among others.

Rouhani: Nuclear deal beneficial to Iran, region and entire world

By Mohammad Homaeifar

TEHRAN — The nuclear deal is definitely to the benefit of Iran, region and the whole world, President Hassan Rouhani said on Sunday.

During the last meeting of Rouhani's first cabinet, the president pointed to the benefits of the nuclear agreement, or the JCPOA, and warned against any breach of it.

Anyone who tries to harm the deal would in fact be harming himself and his own country, Rouhani said in an obvious reference to U.S. President Donald Trump's anti-JCPOA rhetoric.

Trump has been signaling for weeks that he is seeking to find a way out of the deal signed in July 2015 between

Iran, the European Union, Germany and the five permanent members of the UN Security Council. "I don't think they're living up to the spirit of the agreement," Trump said, signaling that he would very much like to declare Tehran noncompliant with the accord.

"They are not in compliance with the agreement and they certainly are not in the spirit of the agreement in compliance, and I think you'll see some very strong things taking place if they don't get themselves in compliance," he went on to say.

This is while his administration has, for two times, certified to the Congress that Iran has been complying with the internationally supported agreement.

The International Atomic Energy Agency has confirmed six times that Iran has been living up to its obligations under the deal, which obliges Iran to limit its nuclear activities in exchange for termination of financial and economic sanctions. The nuclear deal went into force in January 2016.

Once, Rouhani said, the whole world was in complete unison against Iran and its activities, "but today, if America tries to stand against BARJAM (a Farsi acronym for the deal), the whole world would be united against it." Under a new Republican White House, the United States has ramped up pressure on Iran, imposing new sanctions on Tehran over its missile program.

Majlis approves bill to counter U.S. Iranian parliament votes to boost military budget in response to U.S. sanctions

By Negar Asadi

TEHRAN — The Iranian Parliament voted overwhelmingly on Sunday to approve the outlines of a bill to counter the "U.S. terrorist and adventurist acts in the region", boosting by more than 500 million dollars investment in missile defense industry and operations by the IRGC Quds Force.

Out of 247 MPs present in the parliament, 240 MPs voted for the bill.

The 27-point bill, which will be surely endorsed by the Guardian council for implementation, tasks the government to allocate an additional \$260 million for the "development of the missile program" and the same amount to the Quds Force to fight terrorism.

The bill will also impose sanctions on U.S. military and intelligence officials in the region. The bill is in response to the newest round of U.S. sanctions against Iran.

The U.S. Congress in late July adopted a legislation against Iran for its defensive missile program, alleged human rights violations, and what they called Iran's "destabilizing" role in the region.

Parliament National Security and Foreign Policy Committee spokesman Hossein Naqavi Hosseini said that the bill does not violate the Joint Comprehensive Plan of Action, the official name for the nuclear agreement.

Parliament Speaker Ali Larijani said the bill is very important and the government is tasked to take actions in accordance with the ratification. He added the Iranian parliament will monitor the U.S. behavior.

"The U.S. should know that the bill to counter the U.S. adventurism and terrorist acts was the first step that parliament took," he stated.

Iranian Deputy Foreign Minister Abbas Araghchi said that the bill is a "firm" response to U.S. animosity and crimes.

"This bill is part of the JCPOA overseeing committee to counter the recent U.S. Congress approval and is supported by the Foreign Ministry and the government," Araghchi stated. Araghchi also said the bill was not in violation of the nuclear agreement.

MP Mohammadreza Sabbaqian said the U.S. hostile actions against Iran are clear to all and the bill should consider more strict acts to counter the U.S.



IN THE NAME OF GOD

ISLAMIC REPUBLIC OF IRAN BROADCASTING

INTERNATIONAL TENDER NO. 96-05/119

First Announcement

Tender Holder:
ISLAMIC REPUBLIC OF IRAN BROADCASTING (IRIB)

Subject of Two-Stage Tender:
Supply of five chillers with an integrated permanent aerial condenser with the capability of Built-in Free Cooling with the minimum capacity of 1200 actual KW, appropriate to the climatic condition of Tehran city according to the tender documents

Deadline of Receiving Documents:
As of publishing second announcement of advertisement latest by the business hour dated **August 20, 2017.**

Place of Receiving Documents:
Secretariat of Tenders' Commission, Technical Purchasing (KALA) Dept., Media Technology and Development Deputy Office, Bldg. No. 2, IRIB, Jam-e Jam St., Vali-e Asr Ave., Tehran

Type and Amount of Guarantee for Participating in Tender:
The amount of USD **58,874** which should be in the form of extendable bank guarantee (its equivalent of rials guarantee letter with the free rate of 1.2 coefficient)

Time and Place of Delivering Priced Bid:
The sealed A, B & C packages/envelopes should be submitted within one main envelope marked with tender number no later than 15 p.m. on **Wednesday Sept. 20, 2017** and submitted to the Secretariat of Commission of Tenders.

Time and Place of Opening Envelopes
The date of opening envelopes A&B is at **8:30 a.m. on Tuesday Sept. 5, 2017** in the office of Vice President of IRIB Planning and Financial Resources and opening of envelope C will be after technical evaluation.
It should be noted that bidders should hold license from the authorized bodies.

For more information, please contact the following phone numbers: 0098-21-22166313
It is obvious that cost of publishing two advertisements shall be borne by the winner of tender.
E-mail Address: offer@irib.ir

Public Relations Dept. of IRIB

Virginia police, FBI probe deadly violence at white nationalist rally

United States authorities investigate on Sunday the violence stemming from a white nationalist rally a day earlier that killed one person, injured more than 30, and challenged the U.S. President Donald Trump's leadership.

The unrest in the southern college town presented Trump with a domestic crisis, with many on both left and right criticizing him for waiting too long to address it and then, when he did so, failing to explicitly condemn the white-supremacist marchers who ignited the melee.

"Absolutely we are going to have further demonstrations in Charlottesville, because our constitutional rights are being denied," said Jason Kessler, identified by civil rights groups as a white nationalist blogger. He did not specify when.

Kessler organized the "Unite the Right" rally in Charlottesville against a plan to remove a statue to Confederate war hero Robert E. Lee from a park, saying in a telephone interview those who came in support will not back down.

Four people were arrested in the violence, including James Fields, a 20-year-old white man from Ohio being held in jail on suspicion of plowing a car into a crowd of counter-protesters on Saturday, killing a 32 year-old woman and injuring 19, five of them critically.

Police have not yet provided a motive for the incident but U.S. attorneys and the Federal Bureau of Investigation (FBI) have opened a civil rights investigation into the crash, an FBI field office said.

Federal authorities were also looking into a helicopter crash on Saturday that killed two Virginia state policemen aiding efforts to quell the clashes.

Virginia Governor Terry McAuliffe, a Democrat, declared an emergency and halted the white nationalist rally planned for Saturday but that did not stop the violence.

About 15 people were injured after rival groups fought pitched battles using fists, rocks and pepper spray.

"Please go home and never come back," was McAuliffe's message for the white supremacists, delivered at a news conference.

"There is no place for you here, there is no place for



you in America," he added.

Trump said "many sides" were involved in the Charlottesville incidents, remarks that drew fire from across the political spectrum for not specifically denouncing white nationalists.

"We condemn, in the strongest possible terms, this egregious display of hatred, bigotry and violence on many sides," Trump told reporters at his New Jersey golf course on Saturday.

The planned rally stemmed from a long debate in the U.S. South over the Confederate battle flag and other symbols of the rebel side in the Civil War, which was fought over slavery.

The Charlottesville violence is the latest clash between far-rightists, some of whom have claimed allegiance to Trump, and the president's opponents since his January inauguration, when black-clad anti-Trump protesters in Washington smashed windows, torched cars and clashed with police, leading to more than 200 arrests.

About two dozen people were arrested in Charlottesville in July when the Ku Klux Klan rallied against the plan to remove the Lee statue. Torch-wielding white nationalists also demonstrated in May against the removal.

(Source: Reuters)

Latin America rejects U.S. military threat in Venezuela

Several Latin American nations have come out strongly against the United States President Donald Trump's threat of military intervention to solve the ongoing political crisis in Venezuela.

In surprise comments on Friday, Trump asserted a "military option" could be considered, which Venezuela's Defense Minister Vladimir Padrino slammed as "an act of craziness".

Foreign Minister Jorge Arreaza said Venezuela rejected "hostile" threats and called on Latin America to unite against Washington.

President Nicolas Maduro and his government have faced strong criticism from several Latin American nations over the controversial Constituent Assembly, which has the power to rewrite the country's constitution.

Firing back at Trump's threat, Maduro's son - speaking as a newly elected assembly member - said rifles would "arrive and take the White House" if Venezuela was "tarnished" by the U.S. military intervention.

Nicolas Maduro Guerra said Trump should solve his own problems and promised that - should the U.S. attack Venezuela - the Vietnam War "would seem small in comparison".

Peru, one of Maduro's fiercest crit-

ics, led the charge in criticizing Trump's threat, saying it was against United Nations principles.

"All foreign or domestic threats to resort to force undermine the goal of reinstating democratic governance in Venezuela, as well as the principles enshrined in the UN charter," said Peru's Foreign Minister Ricardo Luna.

Mexico and Colombia joined in with statements of their own.

"All measures should be peaceful and respect the sovereignty of Venezuela," a statement from Colombia's foreign ministry said.

Regional alliance Mercosur added it rejected the use of force against Venezuela, despite having indefinitely suspended the country last week amid international condemnation of Maduro's new, all-powerful legislative super-body.

After four months of deadly protests against his government, Maduro says the assembly is Venezuela's only hope of obtaining peace by locking in the socialist policies of his mentor and predecessor, the late Hugo Chavez.

Al Jazeera's Lucia Newman, reporting from the Chilean capital Santiago, said Trump's comments have "raised alarm bells from Mexico to Pantagonia".

(Source: Al Jazeera)

Anti-Bibi protesters: Israel, collapsing

Thousands of protesters gathered in a northern Israeli city for a 38th consecutive week, united in their cause to protest against Prime Minister Benjamin Netanyahu, whom they accuse of unforgivable corruption.

Widely referred to as Bibi, Netanyahu is the subject of two high-profile graft cases. In Case 1000, he is suspected of having received gifts from businessmen overseas.

He is also being investigated in Case 2000 for an alleged media bribery scheme to help Yediot Aharonot newspaper against its competitor Yisrael Hayom in return for favorable coverage.

The rallies were held in the city of Petah Tikva outside the house of Israeli Attorney-General Avichai Mandelblit late on Saturday.

The demonstrators chanted Israel "is collapsing," and some held up placards reading, "Bibi resign."

They also condemned Mandelblit's alleged conduct during his questioning of Netanyahu over corruption-related allegations. They accused him of receiving monetary gifts from a number of businessmen, which may have affected the investigation process, shouting, "Both an

investigator and a friend."

No more than roughly 350 pro-Netanyahu demonstrators also turned up at the site, led by members of Knesset (Israeli Parliament) David Bitan and Nava Boker.

Both groups vowed to repeat the rallies next week.

Late last month, Netanyahu's predecessor Ehud Barak said the current premier had sparked recent tensions at the al-Aqsa Mosque's compound in Tel Aviv-occupied in East al-Quds (Jerusalem) in a bid to distract public attention from the investigations.

Netanyahu "is ready to set ... the region on fire in order to save himself from his fear of criminal investigations," Barak said.

The tensions erupted after a deadly shootout on July 14 outside the compound, known as Noble Sanctuary "Haram al-Sharif", which Jews call Temple Mount. Using the gunfight as a pretext, Israel first closed the compound for three days, and then set up metal detectors and surveillance cameras at entrances to the compound, outraging Palestinians and Muslims around the world.

(Source: al Alam)

Saudi forces cordon off Shia town of Awamiyah: HRW

Human Rights Watch (HRW) says the House of Saud regime forces have encircled the predominantly Shia town of Awamiyah and sealed it off since July, raising concerns about the humanitarian situation there.

The New York-based rights organization cited five Awamiyah residents and three activists as saying on Sunday that the town's residents are at risk, with Saudi regime security forces "arbitrarily shooting at or arresting those who emerged from their houses."

Since July 26, they said, Saudi regime authorities have prevented emergency services from reaching the wounded and failed to provide humanitarian assistance to trapped Awamiyah citizens.

The residents also noted that an order had never been issued for people to leave Awamiyah while their only chance out of the town had been short periods coordinated with local volunteers and activists.

Saudi regime forces turn away anyone who tries to return to Awamiyah to check on relatives or recover possessions, they added.

The residents further complained that the Awamiyah electricity grid have been damaged and all clinics as well as pharmacies have been closed

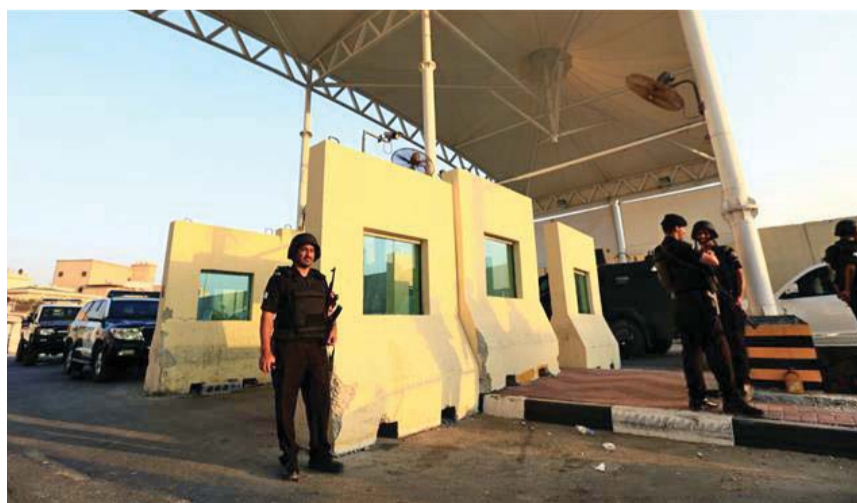

since May.

"Saudi security forces should provide essential services to trapped Awamiyah residents and make sure they can move in and out of the town safely," said Sarah Leah Whitson, Middle East director at HRW.

She also urged Riyadh to hold security forces accountable if probes showed that they had fired at residents unlawfully.

"Saudi authorities should also immediately and credibly investigate whether

its forces used excessive force in Awamiyah," Whitson pointed out.

She said Saudi citizens in Awamiyah face discrimination every day, and for the last three months, they have been caught in the crossfire.

She further called on Saudi regime officials "to allow people to safely return home, allow business and clinics to reopen, and compensate residents for property damage and destruction caused by security forces."

The HRW warned that significant

damage has been inflicted on Awamiyah based on an assessment of satellite imagery from February and August.

Awamiyah, situated in Eastern Province, has long been a flashpoint between the House of Saud regime and the inhabitants complaining of discrimination.

It has witnessed renewed deadly clashes between the military and residents since May, when Saudi regime forces began razing the town's old quarter, known as al-Mosawara.

Saudi regime authorities claim that Mosawara's narrow streets have become a hideout for militants suspected of being behind attacks on security forces in Eastern Province.

Critics, however, say Saudi Arabia is trying to bring a demographic change to the city, erasing cultural heritage and violating human rights through Mosawara's demolition.

Stephane Dujarric, the spokesman for the United Nations Secretary General Antonio Guterres, said recently that the world body could not independently verify the reports coming out of Awamiyah, but that all Riyadh's actions should be in line with its commitments to human rights.

(Source: Press TV)

Analyst says Trump will continue wrongheaded policies toward Russia, China

BY Jalal Heirannia

TEHRAN — U.S. columnist Stephen Lendman tells the Tehran Times that Donald Trump is making threats against Iran and North Korea more and will continue "wrongheaded policies toward Russia and China".

Following is the text of the interview:

Q: What will be Donald Trump's legacy for domestic politics?

A: He's been deplorable across the board, especially on banning travel by Muslims from designated countries, his deplorable health-care plan, and one-sidedly supporting monied interests at the expense of the general welfare.

Q: What about his foreign policy?

A: His foreign policy escalated Obama's wars. He's threatening more against North Korea and Iran, along with continuing wrongheaded policies toward Russia and China, as well as seeking to replace democracy in Venezuela with fascist tyranny.

Q: Trump's rise to power was mainly owed to his slogan of "Making America Great Again". What have been made in this regard so far?

A: I deplore the slogan, a spinoff from American exceptionalism. It's only exceptional in waging war on humanity at home and abroad.

Q: How will be the U.S. after Trump? Will it be more powerful or weaker?

A: Each U.S. administration since the 1970s has been worse than its predecessors. Obama was worst of all and Trump so far exceeds him.

At the same time, he's hamstrung by bipartisan neo-cons in Congress wanting him replaced by someone even worse, more easily controlled like VP Pence, a deplorable possibility.

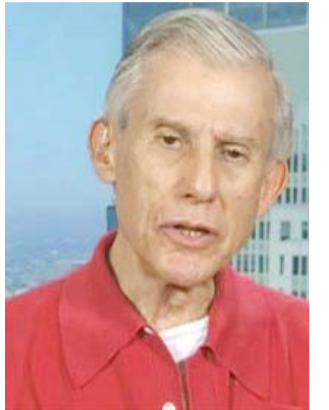

Argentina primary vote measures appetite for populist ex-president

Argentines vote on Sunday in a closely watched mid-term primary election that will test their appetite for bringing back the left-wing populism of former President Cristina Fernandez.

Fernandez, who was indicted for corruption last year, is vying for a Senate seat in Buenos Aires province, home to nearly 40 percent of the country's voters. She is running against business friendly President Mauricio Macri's former education minister and other candidates from a divided opposition.

Investors and wealthy Argentines fear a Fernandez comeback in Congress could pave the way to her running for president in 2019. Her return to power would likely mean the end of Macri's reforms and a resumption of rampant spending, protection of industry and isolation from trade agreements and international capital markets.

A seat in Congress would give the 64-year-old Fernandez immunity from arrest, though not from trial. She dismisses the corruption accusations as politically motivated.

The compulsory primary vote on Sunday will essentially serve as a detailed poll ahead of the Oct. 22 election for one third of the Senate and half the lower house of Congress, as no major candidates are being challenged from within their own parties.

Though her chosen successor lost to Macri in Buenos Aires province in 2015, Fernandez now appeals to many in its struggling industrial belt, where Argentina's emergence from recession in the second half of last year has yet to take hold.

The final weeks of primary campaigning were marked by repeated headlines highlighting gaffes from Esteban Bullrich, Macri's former education minister and scion of a wealthy Buenos Aires family. On Wednesday he apologized for calling the jailing of young people "progress."

Bullrich had previously suggested craft beer as an alternative employment opportunity for Argentines who had lost their jobs and was criticized by feminists for a radical anti-abortion stance.

Fernandez, who broke with Argentina's main opposition movement of Peronism for the election as some adherents form more moderate factions, meanwhile ran a relatively subdued campaign compared to her often fiery rhetoric and long speeches as president.

"We weren't always as humble as we should have been," she said of her presidency at her final rally.

Peso weakening

Meantime, Argentina's peso has weakened around 9 percent since Fernandez, who was president from 2007 to 2015, formed a new political party and declared her candidacy on June 24 even as the central bank sold \$1.8 billion to curb the currency's drop.

In an interview for the Reuters Latin America investment summit, Macri admitted the race would be tight in Buenos Aires province but insisted that, more importantly, his coalition would win on a national level.

No matter how many seats his "Let's Change" coalition picks up, Macri will still lack a majority in Congress and continue to need to build alliances to pass reforms.

An opponent like Fernandez representing the country's most powerful economic district could make that all the more difficult.

(Source: Reuters)

NEWS IN BRIEF



Mounesan named Iran's new tourism chief

ECONOMY TEHRAN — President Hassan Rouhani in a decree on Sunday appointed Ali-Asghar Mounesan as the new director of the Cultural Heritage, Tourism, and Handicrafts Organization.

Mounesan, 47, holds a PhD in civil engineering from Tehran's Sharif University of Technology. He has served as the managing director of Kish Free Zone Organization.

He replaced Zahra Ahmadipour who held the post since November 2016.



92% of predicted VAT earned in 4 months

ECONOMY TEHRAN — Iran could earn 92 percent of its expected Value Added Tax (VAT) in the first four months of the current Iranian calendar year (March 21- July 22, 2017), an official in the country's National Tax Administration was quoted by Tasnim news agency on Sunday.

While the Iranian government has not increased VAT rate recently, it could earn 120.1 trillion rials (about \$3.15 billion) of VAT during the said period, showing a growth of 10 percent in comparison to the same time in the preceding year, Mohammad Mashihi said.



Beans annual output to grow 7% by Mar. 2018

ECONOMY TEHRAN — Iran's production of beans is expected to grow seven percent by the end of the present Iranian calendar year (March 20, 2018), an official from the country's ministry of agriculture announced on Sunday.

As ILNA quoted Kaveh Khaksari as saying, Iran plans to produce 737,000 tons of beans by the said time, while its last year's output stands at 690,000 tons.

Total's deal 'breaks the ice', Iran says

ENERGY TEHRAN — Iranian Deputy Oil Minister for International Affairs and Trading Amir-Hossein Zamaninia has said that the deal with Total breaks the ice of foreign investment in Iran's economy.

In early July, Iran signed a deal with France's giant Total and China's state-owned National Petroleum Corporation (CNPC) for development of phase 11 of its South Pars gas field (shared with Qatar in the Persian Gulf).

The \$4.879-billion deal was signed by National Iranian Oil Company (NIOC), as the contractor of project, and a consortium of companies comprising Total, CNPC and Iran's Petropars.

"When Total ignores any risk of investment in Iran it could be a model for the other international companies, as they see that the door is open and the way is paved", Zamaninia said in an interview with Persian language Etamad newspaper.

"Of course, we should not exaggerate the importance of this deal, as we know that Iran deserves much more than this and the foreigners should vie for presence and investment in Iran," he added.



No concern over Total's deal with Qatar

As Total has also a deal with Qatar on development of the giant gas field, which is called North Dome in the Qatari side, Zamaninia was asked that if there is any concern about the French company's concurrent presence in both sides.

He said there is no concern as Total's share in the Qatari side is about four percent which is very small.

Joint fields a priority

The deputy oil minister next was

asked that if Oil Ministry prioritizes Russian companies or European ones for signing the contracts.

He said: "There is no difference between them. Our priority is development of the joint fields and companies make no difference for us."

Double effort needed after sanctions

Mentioning the issue of Iraq's increasing its oil output despite the war and its critical domestic condition and also given that the neighboring country has

a number of joint fields with Iran, the official was asked that if he considers such thing a weakness for Iran.

He replied: "Iraq's success is because all big international companies can work in that country. Oil giants of the U.S. and Europe have brought investment and technology to Iraq and are working there. But, we move relying on our own investment and knowledge. It is an honor for us but now that the sanctions are lifted we should work with double effort."

OPEC's success more than anticipation

Asked about his idea of the decision made by Organization of the Petroleum Exporting Countries (OPEC) for cutting oil production by its members and the organization's compliance in this due, Zamaninia said: "I believe that their success was more than anticipated. The members complied with the decision. Although some say that the price did not go up, we should imagine that if there was no such decision in OPEC what would happen and how the price would fall."

"Anyway, I think that the oil price will be strengthened in the last quarter of 2017", he opined.

Iran in talks to buy 48 Airbus helicopters

DUBAI (Reuters) — Iran is holding talks with European plane maker Airbus to buy 48 helicopters for civilian use, an Iranian official was on Saturday quoted as saying, as Iran continues its shopping spree of Western aircraft after the lifting of sanctions.

"The Health Ministry is planning to order 45 HEMS (Helicopter Emergency Medical Service) helicopters and the purchase is being negotiated by the Ministry of Roads and Urban Development," Iran's Financial Tribune daily quoted Deputy Minister Asghar Fakhrieh-Kashan as saying.

"Ports and Maritime Organization is also planning to hold a tender to purchase three search-and-rescue helicopters," he added.

An Airbus Helicopters spokesman said: "We don't comment on discussions we may or may not be having with potential customers."

Iran has ordered more than 200 planes since international sanctions against the country were lifted last year in return for curbs on the country's nuclear activities.

Flag-carrier Iran Air has ordered 100 planes from Airbus, 80 from U.S. rival Boeing and 20 ATR turboprops.

In June, Airbus said two other Iranian airlines had committed to buying 73 planes in a last-minute flurry of deals for the aircraft manufacturer at the Paris Airshow.

Fakhrieh-Kashan said Iran was holding negotiations to merge the helicopter order into the Iran Air-Airbus contract signed in December, Financial Tribune reported.

Some 465 million shares worth 1.14 trillion rials (about \$206.9 million) were traded through 42,000 deals in TSE.

PIX fell 101 points to 81,661 in the same day.

Some 465 million shares worth 1.14 trillion rials (about \$206.9 million) were traded through 42,000 deals in TSE.

Also, Tehran Stock Exchange (TSE)'s main index (TED-

PIX) fell 101 points to 81,661 in the same day.

PIX) fell 101 points to 81,661 in the same day.

Fara Bourse's main index up 1.2 points in a day

ECONOMY TEHRAN — IFX, the main index of Iran's over-the-counter (OTC) market known also as Iran Fara Bourse (IFB), rose 1.2 points to 920 on Sunday, Tasnim news agency reported.

As reported, 210 million securities worth 940 billion rials (about \$24.8 million) were traded in 28,000 deals on Sunday.

Also, Tehran Stock Exchange (TSE)'s main index (TED-

PIX) fell 101 points to 81,661 in the same day.

Some 465 million shares worth 1.14 trillion rials (about \$206.9 million) were traded through 42,000 deals in TSE.

PIX) fell 101 points to 81,661 in the same day.

PIX) fell 101 points to 81,661 in the same day.

PIX) fell 101 points to 81,661 in the same day.

PIX) fell 101 points to 81,661 in the same day.

PIX) fell 101 points to 81,661 in the same day.

PIX) fell 101 points to 81,661 in the same day.

PIX) fell 101 points to 81,661 in the same day.

PIX) fell 101 points to 81,661 in the same day.

PIX) fell 101 points to 81,661 in the same day.

PIX) fell 101 points to 81,661 in the same day.

PIX) fell 101 points to 81,661 in the same day.

PIX) fell 101 points to 81,661 in the same day.

PIX) fell 101 points to 81,661 in the same day.

PIX) fell 101 points to 81,661 in the same day.

PIX) fell 101 points to 81,661 in the same day.

PIX) fell 101 points to 81,661 in the same day.

PIX) fell 101 points to 81,661 in the same day.

PIX) fell 101 points to 81,661 in the same day.

PIX) fell 101 points to 81,661 in the same day.

PIX) fell 101 points to 81,661 in the same day.

PIX) fell 101 points to 81,661 in the same day.

PIX) fell 101 points to 81,661 in the same day.

PIX) fell 101 points to 81,661 in the same day.

PIX) fell 101 points to 81,661 in the same day.

PIX) fell 101 points to 81,661 in the same day.

PIX) fell 101 points to 81,661 in the same day.

PIX) fell 101 points to 81,661 in the same day.

PIX) fell 101 points to 81,661 in the same day.

First Announcement

IN THE NAME OF GOD
ISLAMIC REPUBLIC OF IRAN BROADCASTING
INTERNATIONAL TENDER NO. 96-05/117

Tender Holder:
ISLAMIC REPUBLIC OF IRAN BROADCASTING (IRIB)

Subject of Two-Stage Tender:
Supply of diesel generator (prime) including six generators with the capacity of 2400 KV/ampere in LV level, appropriate to the climatic condition of Tehran city according to the tender documents

Deadline of Receiving Documents:
As of publishing second announcement of advertisement latest by the business hour dated **August 20, 2017**.

Place of Receiving Documents:
Secretariat of Tenders' Commission, Technical Purchasing (KALA) Dept., Media Technology and Development Deputy Office, Bldg. No. 2, IRIB, Jam-e Jam St., Vali-e Asr Ave., Tehran

Type and Amount of Guarantee for Participating in Tender:
The amount of USD **113,059** which should be in the form of extendable bank guarantee (its equivalent of rials guarantee letter with the free rate of 1.2 coefficient)

Time and Place of Delivering Priced Bid:
The sealed A, B & C packages/envelopes should be submitted within one main envelope marked with tender number no later than 15 p.m. on **Wednesday Sept. 20, 2017** and submitted to the Secretariat of Commission of Tenders.

Time and Place of Opening Envelopes
The date of opening envelopes A&B is at **8:30 a.m.** on **Tuesday Sept. 5, 2017** in the office of Vice President of IRIB Planning and Financial Resources and opening of envelope C will be after technical evaluation.
It should be noted that bidders should hold license from the authorized bodies.

For more information, please contact the following phone numbers: 0098-21-22166313
It is obvious that cost of publishing two advertisements shall be borne by the winner of tender.
E-mail Address: offer@irib.ir

Public Relations Dept. of IRIB

First Announcement

IN THE NAME OF GOD
ISLAMIC REPUBLIC OF IRAN BROADCASTING
INTERNATIONAL TENDER NO. 96-05/118

Tender Holder:
ISLAMIC REPUBLIC OF IRAN BROADCASTING (IRIB)

Subject of Two-Stage Tender:
Supply of 10 Uninterrupted Power Supply (UPS) with the capacity of 500KV/ampere along with the related batteries (15 minutes) according to the tender documents

Deadline of Receiving Documents:
As of publishing second announcement of advertisement latest by the business hour dated **August 20, 2017**.

Place of Receiving Documents:
Secretariat of Tenders' Commission, Technical Purchasing (KALA) Dept., Media Technology and Development Deputy Office, Bldg. No. 2, IRIB, Jam-e Jam St., Vali-e Asr Ave., Tehran

Type and Amount of Guarantee for Participating in Tender:
The amount of USD **64,962** which should be in the form of extendable bank guarantee (its equivalent of rials guarantee letter with the free rate of 1.2 coefficient)

Time and Place of Delivering Priced Bid:
The sealed A, B & C packages/envelopes should be submitted within one main envelope marked with tender number no later than 15 p.m. on **Wednesday Sept. 20, 2017** and submitted to the Secretariat of Commission of Tenders.

Time and Place of Opening Envelopes
The date of opening envelopes A&B is at **8:30 a.m.** on **Tuesday Sept. 5, 2017** in the office of Vice President of IRIB Planning and Financial Resources and opening of envelope C will be after technical evaluation.
It should be noted that bidders should hold license from the authorized bodies.

For more information, please contact the following phone numbers: 0098-21-22166313
It is obvious that cost of publishing two advertisements shall be borne by the winner of tender.
E-mail Address: offer@irib.ir

Public Relations Dept. of IRIB

Why oil dropped last week

By Markos Kaminis

Oil prices dropped precipitously on Thursday, leaving many scratching their heads wondering why. After all, the report from OPEC noting the effects of member non-compliance to production quotas was old news. Still, when OPEC reported its members' production increased by 173K barrels a day as a result, to average 32.87 million barrels in July, many were still surprised. The United States Oil ETF (NYSE: USO) dropped 2.4% on the day, and was down 1.4% on the week because of it.

Oil dropped last week, but recovered some ground on Friday, with the United States Oil ETF regaining some 0.8% Friday. So where do we go from here?

Thursday's catalyst that collapsed oil from its high point on the week, and while it was seemingly heading to new near-term heights, was OPEC's Monthly Oil Market Report. The key



data that did oil in was found within the world oil supply segment of the report, where OPEC notes July production actually increased by 173K barrels per day.

The reason for the increased production was foretold. OPEC member non-compliance to production quotas in July caused the damage, though we

thought it was addressed for all the audience at OPEC's meeting in Abu Dhabi - apparently not. OPEC members must adhere to the outlined plan or else OPEC loses all credibility and fails to serve its own cause, which is to balance the oil market and to improve profitability through better pricing.

(Source: seekingalpha.com)

Egypt to hold tender for oil exploration in Eastern Desert

CAIRO (Reuters) — Egypt's General Authority for Petroleum (EGPC) announced on Sunday it would hold a tender for oil exploration in the country's Eastern Desert.

The areas open for exploration include Wadi Dara, with a total area of 50 square kilometers, and block G in West Gharib, with an area of 20 square km.

Bids must be submitted by Dec. 28, according to an advertisement EGPC posted in local newspapers.

Egypt has been pushing for new oil and gas discoveries and speeding up production at existing fields, aiming to cut down on imports and return to exporting natural gas in coming years.

India's renewables could overtake coal-fired capacity in 2027

In what reinforces bullish outlook on solar energy, India's renewable power is projected to overtake coal-fired generation capacity in a decade from now.

Renewable energy could equal coal-fired generation capacity in 2026 and exceed it a year later, said the second volume of the Economic Survey.

At present, India's installed power capacity is 327 GW of which thermal power from coal comprises 192.16 GW or 55% of the total, while renewable energy capacity is 57.26 MW or 18% of the total. India has set itself the

goal of 175 GW of renewable power capacity by 2022 and 275 GW by 2027.

But coal capacity is expected to increase by only 50 GW by 2022 and thereafter remain almost constant, as a result of which by 2027, coal-based power capacity will 248.51GW, or a shade less than that of renewables.

However, that will depend on the ambitious yearly energy targets being persistently achieved.

Already in 2016-17, installed renewable capacity increased by 24.5%, while thermal went up by merely 5.3%.

The survey notes that the cost of

renewable energy has fallen drastically in recent years putting economic cost of solar and wind power almost on par with that of thermal power.

It points out that the levelised cost of electricity from solar halved between 2010 and 2014 and has fallen further since to a record low of Rs 2.44 per kWh at a solar auction in Rajasthan in May. It notes that wind tariffs too have dropped, though not as dramatically. But the survey also provides a detailed analysis of the social costs of both coal-based energy and renewable energy.

(Source: energyinfrapost.com)

INVITATION FOR SUBMISSION OF PREQUALIFICATION BIDS

TENDER NO. 96/1006
(PROJECT TYPE EPCF)

Second announcement



Khuzestan Water and Waste Water Company

On the basis of Clause (C) defined in Item 12 of the Operational Regulations of the Islamic Republic of Iran (IRI) Tendering Laws and Regulations circulars 100/50252 dated 23/08/09 and 100/135946 dated 12/11/2006 issued by the offices of Country Planning and Budget Organization, the Khuzestan Water and Wastewater Company proposes to tender the project below on an EPCF (Engineering, Procurement, Construction and Installation and Finance) basis to Bidders with the required qualifications and with sufficiently open capacity as follows:

Tender No.	Title of Tender	Specialization Required (Having at Least One of the Requirements Below)	Location of Document Sales	Duration for Procurement of Bidding Documents	Date and Place for Opening of Tenders
96/1006	The Construction of the Primary Module for Urban Wastewater Treatment Plants in the Cities of Shosh, Andimeshk, Izeh, Behbahan and Bostan on an EPCF Basis	1- Bidders with a number one ranking of EPC in Water, specializing in Water and Wastewater 2- Bidders with a number one ranking in Water, conditional to the introducing of a Consulting Engineer with the same ranking in Water Engineering specializing in Water and Wastewater Installations (in the form of public joint venture)	Anhar Jonoub	Until 23/Aug./2017	At 13 O'clock in the morning on 23/Sept./2017

Criteria for the Evaluation of Prequalification Bids

In addition to the criterion defined in the Prequalification documents of the aforementioned tender, and with due regards to the fact that the estimated project costs exceed that of Bidders with a number one ranking in the required specializations, all participants in the Bid must have the following conditions:

- 1- The Bidder's company must be registered in the IRI National Tendering Data Base i.e. <http://iets.mporg.ir> and that of the Presidential Deputy for Strategic Planning and Control's database i.e. <http://tec.mporg.ir>
 - 2- The having of an Open Capacity in the First Class ranking of the specialization(s) required
 - 3- The execution and implementation of at least one similar project within the past five years with a total cost of at least one third of the current project's estimated project costs updated on the basis of current global inflation indices.
- Meanwhile, the contractors shall provide an agreement with foreign funder to supply 85 percent of the project funding requirements.

Address and Location for Purchasing of Prequalification Bidding Documents

Anhar Jonoub Consulting Company No. 1075, 11th Floor, Apartment 1103, Vali-e Asr Ave., before Sayee Park, Opposite the Filling Station, Shahab Building, Tehran
Tel: +98-(0) 21-88701438 and 88727855

Anhar Jonoub Consulting Company No. 98th, West Mohan Street, at the end of Phase 11, Kianpars Area, Ahwaz – Khuzestan
Tel: +98-(0)61 – 33914548

The final date for the submission of completed Prequalification Bid documents will be before nine O'clock in the morning on the day of opening of Tenders.

Address and Location for the Submission of Prequalification Bidding Documents
Security and Confidential Matters Secretariat's Offices, fifth Floor, the Khuzestan Water and Wastewater Company, 1st Square, Kianpars, Ahwaz

The Prequalification Bids submitted will be opened in the Contractual Department of the Ahwaz Water and Wastewater Company in the presence of the Bidders.

Electronic Address of Tender; Main Client, www.abfakhz.ir and IRI National Tendering Data Base: <http://iets.mporg.ir>

Public Relations and Education Department of the
Khuzestan Water and Wastewater Company

IN PARTNERSHIP WITH **REALTEAM**

RAYMOND WEIL is proud to be supporting Swiss sailing team Realteam as its Official Timing Partner and to introduce a new freelancer able to support the crew in the most extreme sailing conditions. A nice little tip of the hat to Mr Raymond Weil who was a member of the Geneva Yacht Club.

Join the discussion #RWRRealteam

SARMAN Co.

No. 1832, Dr. Shariati St., Next to Pol-E-Roomi, Tehran - Iran

freelancer collection

Charlottesville and the bigotocracy

The late, great Gore Vidal said that we live in "The United States of Amnesia." Our fatal forgetfulness flares when white bigots come out of their closets, emboldened by the tacit cover they're given by our president. We cannot pretend that the ugly bigotry unleashed in the streets of Charlottesville, Va., last weekend has nothing to do with the election of Donald Trump.

In attendance was white separatist David Duke, who declared that the alt-right unity fiasco "fulfills the promises of Donald Trump." In the meantime, Mr. Trump responded by offering false equivalencies between white bigots and their protesters. His soft denunciations of hate ring hollow when he has white nationalist advisers like Steve Bannon and Stephen Miller whispering in his ear.



Such an ungainly assembly of white supremacists rides herd on political memory. Their resentment of the removal of public symbols of the Confederate past — the genesis of last weekend's rally — is fueled by revisionist history. They fancy themselves the victims of the so-called politically correct assault on American democracy, a false narrative that helped propel Mr. Trump to victory. Each feeds on the same demented lies about race and justice that corrupt true democracy and erode real liberty. Together they constitute the repulsive resurgence of a virulent bigotry.

Virulent bigotry

This bigotry overlooks fundamental facts about slavery in this country: that blacks were stolen from their African homeland to toil for no wages in American dirt. When black folk and others point that out, white bigots are aggrieved. They are especially offended when it is argued that slavery changed clothes during Reconstruction and got dressed up as freedom, only to keep menacing black folk as it did during Jim Crow. The bigotry is angry that slavery is seen as this nation's original sin. And yet they remain depressingly and purposefully ignorant of what slavery was, how it happened, what it did to us, how it shaped race and the air and space between white and black folk, and the life and arc of white and black cultures.

You agree to receive occasional updates and special offers for The New York Times's products and services.

They cling to a faded Southern aristocracy whose benefits — of alleged white superiority, and moral and intellectual supremacy — trickled down to ordinary whites. If they couldn't drink from the cup of economic advantage that white elites tasted, at least they could sip what was left of a hateful ideology: at least they weren't black. The renowned scholar W.E.B. Du Bois called this alleged sense of superiority the psychic wages of whiteness. President Lyndon Baines Johnson once argued, "If you can convince the lowest white man he's better than the best colored man, he won't notice you're picking his pocket. Hell, give him somebody to look down on, and he'll empty his pockets for you."

We have a bigoted billionaire-cum-president who has done precious little for the white working class whose resentment fueled his rise. They have emptied their ethical and economic pockets in support of him even though he turned his back on them the moment he entered the Oval Office. The only remnant of his leadership they have to hold on to is the folklore of white nationalist sentiment, and xenophobic passion, that offer them psychic comfort if little financial stability.

A vile replay of history

It is disheartening for black folk to see such a vile and despicable replay of history. Facing this unadorned hate tears open wounds from atrocities that we have confronted throughout our history. It is depressing to explain to our children that what we confronted as children may be the legacy they bequeath to their children as well.

Now is the time for every decent white American to prove he or she loves this country by actively speaking out against the scourge this bigotry represents. If such heinous behavior is met by white silence, it will only cement the perception that as long as most white folk are not immediately at risk, then all is relatively well. Yet nothing could be further from the truth, and nothing could more clearly declare the moral bankruptcy of our country.

(Source: The NYT)

European politicians are ignoring illegal migration

The political elite across Europe has proved utterly inept when it comes to confronting and dealing with the migrant crisis.

This is not a problem confined to a single country or being caused by a solitary government. What we are witnessing is a continent-wide refusal to treat the issue of illegal migration with the seriousness it deserves.

The shocking scenes as a boatful of suspected migrants arrived on a tourist beach in Spain are a graphic reminder of the consequences of the EU's failure to secure its southern border and to discourage migrants from sailing across the Mediterranean.

Instead of following up this success with further policies to bring the situation under control, ministers just reverted to business as usual and now migrants are flocking back to the port.

Nothing has changed and no improvement has been achieved.

Besides imposing tougher border checks on harmless British tourists, it is difficult to see what European leaders are doing to remedy this. Despite the clear and obvious anger that people across Europe feel regarding the migrant crisis, the out-of-touch political class just does not seem to care.

(Source: express.co.uk)

Why is Kuwaiti mediation not working?

The Saudi-led bloc is obstructing Kuwait's efforts to mend the PGCC rift

Kuwait has long played a constructive role in the Persian Gulf Cooperation Council (PGCC) by bringing opposing parties together. It also enjoys strong relations with both Saudi Arabia and Qatar. So when Saudi Arabia, United Arab Emirates (UAE), Egypt and Bahrain cut ties to Qatar in early June, Kuwait was seen as an acceptable mediator that can mend the latest rift within the PGCC.

Sheikh Sabah Al-Sabah served for 40 years as foreign minister (1963-2003), and then as prime minister before becoming the emir of Kuwait in 2006. The vast experience he had in these positions and the intensity of his involvement in the issues that affect the region as a whole made him the right man for this hard task.

So when the crisis erupted, both the Saudi-led bloc and Qatar turned to Al-Sabah. But they had very different motivations for doing so.

For Qatar, Kuwait is a trustworthy neighbor that has no vested interest in any kind of internal PGCC conflict. Also, Sheikh Al-Sabah is praised in Doha as a wise and experienced statesman. Most importantly, Kuwait — as a small country — knows very well from its own experience with Iraq what it is to face aggression from a big and powerful neighbor. Thus Doha believes that Kuwait can easily understand and help to solve the current situation between Qatar and Saudi Arabia and its allies.

On the other hand, the Saudi-led bloc has a very different perspective regarding the nature of the role Kuwait can play in this crisis. Although they also seem to be welcoming Kuwaiti mediation, their motivation for doing so is to lessen the influence of outside actors in the crisis. They seem to be unwilling to solve the crisis which is posing serious challenges for Kuwait.

Blocking mediation efforts

Even though there is a broad regional and international consensus to support the role of Al-Sabah as a mediator in the crisis, Kuwait was unable to be effective and three rounds of mediation didn't lead to the desired outcomes yet. U.S. President Donald Trump's toxic influence also played a role in the failure of Kuwait's efforts; however, the most important reason behind it was the Saudi-led bloc's refusal to participate in and show any enthusiasm for a meaningful mediation process.

Since the beginning of the crisis, the Saudi-led bloc imposed serious restrictions on the role Kuwait can play in the crisis. By doing so, they wanted to ensure Riyadh's strong influence over small PGCC countries and to force Qatar to comply.

At the very beginning of the crisis, on June 5, Prince Khalid Al-Faisal, adviser of the Saudi King Salman, visited Kuwait to deliver a message to its Emir. Kuwait's state-run news agency KUNA didn't disclose the contents of the message; however, one source with knowledge of the situation told me that "The purpose was to discourage the Emir [of Kuwait's mediation efforts]."

The bottom line here is that without at least neutralizing Trump's negative influence in the crisis and applying pressure on the Saudi-led bloc to participate in meaningful negotiations, Kuwait will likely have no chance to succeed in its mission.

The same source said that at that time: "The Emir of Qatar was preparing to deliver a strong speech with retaliatory measures in response to the measures taken against his country." But, despite Saudi efforts to discourage mediation, "al-Sabah called [Qatar's Emir] Sheikh Tamim bin Hamad Al-Thani and urged him for restraint."

The Emir of Kuwait was interested in avoiding a vicious cycle of destructive actions and reactions by both sides. And Qatar's Emir aided his mediatory mission by not delivering the strong speech he had



U.S. President Donald Trump's toxic influence also played a role in the failure of Kuwait's efforts; however, the most important reason behind it was the Saudi-led bloc's refusal to participate in and show any enthusiasm for a meaningful mediation process.

prepared. However, actions of the U.S. President Donald Trump disrupted Qatar and Kuwait's efforts to de-escalate the situation.

On June 6, a tweet by Trump implying that Qatar is "funding a radical ideology" empowered the Saudi-led bloc, and made Kuwait's job much harder. Following the U.S. president's now infamous tweet, both Saudi Arabia and the UAE escalated their attacks against Qatar. UAE's Minister of State for Foreign Affairs, Anwar Gargash, said: "There is nothing to negotiate with Qatar," thus sabotaging the first round of the Kuwaiti mediation efforts.

During this first round of efforts, the anti-Qatar quartet also refused to disclose the real causes that triggered the crisis and did not present any proof for the serious allegations they had raised against Doha. Furthermore, they did not present a list of demands, guaranteeing the failure of Kuwait's mediation efforts.

Just a mailman

The second round of the Kuwaiti efforts started over a month later, when the Saudi-led bloc finally prepared its list of 13 demands. At this stage, however, the Saudi-led bloc limited the role of Kuwait to a mailman.

Adel Al-Jubair, Foreign Minister of Saudi Arabia, once again made it clear that there would be "no negotiations" with Qatar. Kuwait was only allowed to deliver the list of 13 demands to Doha and receive Qatar's response in a period of 10 days. These restrictions made any Kuwaiti effort for mediation completely futile.

During this time, the U.S. Secretary of State Rex Tillerson made visits to the region to help Kuwait in its mediation efforts, and slight progress was achieved.

According to one Persian Gulf official, "Kuwait asked

Doha not to disclose its response on the 13 demands to the public in order to help its efforts in mediation". The same source told me: "A roadmap and a set of principles were conveyed to the Saudi-led bloc after Doha signed an agreement with U.S. on combating terrorism."

However, at this point of the process, a set of agreements made between Persian Gulf countries between 2013 and 2014, known as Riyadh Agreements, were leaked to American broadcaster CNN, which has regional headquarters in Abu Dhabi. This leak was widely seen as another attempt to block the joint efforts of Kuwait and the U.S. Secretary to solve the crisis.

Despite the Saudi-led bloc's reluctance to help the mediation efforts, on July 22, the Emir of Qatar Sheikh Tamim bin Hamad Al Thani showed willingness and readiness for dialogue in his first speech about the crisis. Yet, only a week after his speech, top officials from the Saudi-led bloc met in Bahrain and reasserted that there would be no negotiations with Qatar unless it fulfills the 13 demands.

For Kuwait, this was like going back to square one again.

At this stage, there is still no direct communication between the opposing sides of the PGCC conflict. Kuwait is deprived from an effective mediation role and the UAE seems to be content with the idea of a stalemate. Because of all this, Kuwaiti efforts for mediation remain fruitless. The bottom line here is that without at least neutralizing Trump's negative influence in the crisis and applying pressure on the Saudi-led bloc to participate in meaningful negotiations, Kuwait will likely have no chance to succeed in its mission.

(Source: Al Jazeera)

U.S. intelligence: North Korea's ICBM reentry vehicles are likely good enough to hit the continental U.S.

By Ankit Panda

North Korea's reentry vehicle technology is likely where it needs it to be, but it may choose to test to longer ranges.

The U.S. Central Intelligence Agency (CIA) has assessed that North Korea's Hwasong-14/KN20 intercontinental-range ballistic missile (ICBM) test launch on July 28 failed to demonstrate successful atmospheric reentry. The Diplomat has learned. The same assessment, however, notes that North Korea's ICBM reentry vehicles would likely perform adequately if flown on a normal trajectory to continental U.S. targets.

U.S. government sources with knowledge of the confidential CIA assessment released in early August note that the reentry vehicle of the Hwasong-14 ICBM launched out of Mupyong-ni on July 28 did not survive to splashdown in the Sea of Japan. The reentry vehicle likely disintegrated; the assessment cites the high lofted trajectory of the July 28 launch as the primary reason for the reentry vehicle's failure.

The CIA assessment notes that based on the two observed flight tests of the Hwasong-14 to date, North Korea's reentry vehicle technology is likely sufficiently advanced to pose no performance problem should the missile be fired at a minimum energy trajectory. The assessment of the reentry vehicle is supported by analysis of data "gathered from ground, sea, and air-based sensors" by the U.S. National Air and Space Intelligence Center (NASIC), one source told The Diplomat.

A ballistic missile's reentry vehicle contains its explosive payload and must withstand immense structural and temperature pressures during its descent through the earth's atmosphere to its intended target. These physical stresses are exceptionally severe in the case of ICBMs, which fly higher than shorter-range systems and reach speeds several multiples of the speed of sound during descent.

According to a U.S. government source with knowledge of the latest ICBM test, the North Korean ICBM's



According to a U.S. government source with knowledge of the latest ICBM test, the North Korean ICBM's reentry vehicle on July 28 would have encountered structural stresses in excess of those it would see during a minimum energy trajectory flight toward continental U.S. targets.

reentry vehicle on July 28 would have encountered structural stresses in excess of those it would see during a minimum energy trajectory flight toward continental U.S. targets.

The missile's full range

The CIA assesses this to be primarily due to the exceptionally high apogee of 3,700 kilometers it reached during the flight; North Korea did this seeking to demonstrate the missile's full range capabilities within the Sea of Japan. Temperature stresses on the RV, meanwhile, would likely last longer during reentry off a minimum energy trajectory flight than they would have during the July 28 flight.

North Korea's own state media statement on the July 28 test did not make any claim that the reentry vehicle survived following the July 28 test. The Korean Central News Agency statement released after the test did note that the "accurate guidance and attitude control of warhead was ensured at the atmospheric reentry at the angle launch system harsher (sic) than the actual maximum range flying conditions" (emphasis added).

After the July 4 test, however, North Korea noted that "the warhead accurately hit the targeted waters without any structural breakdown at the end of its flight" — an exaggerated claim, according to U.S. intelligence assessments.

As The Diplomat has previously reported, the July 4 Hwasong-14 ICBM test saw the reentry vehicle survive to approximately an altitude of 1 kilometer. Despite this, a 30 kiloton nuclear payload — a common estimate for the boosted fission device North Korea is thought to have tested in September 2016 — could be successfully delivered at that altitude using an airburst.

Despite the CIA assessment that North Korea's reentry vehicle technology would perform adequately on a minimum energy trajectory, Pyongyang has yet to prove this given that it continues to avoid overflying Japan and carry out tests of its long-range missiles on lofted trajectories within the Sea of Japan.

However, as a statement released this week suggests, North Korea may soon look to conduct full-range flight tests of its ICBM and Hwasong-12 intermediate-range ballistic missile into the Pacific Ocean. These tests would allow it to prove its reentry vehicle performance under conditions more similar to the kinds of flights these missiles would be required to undertake in operational scenarios to attack the U.S. homeland.

Accordingly, the CIA's assessment also anticipated a future Hwasong-14 launch to prove the reentry vehicle's performance at full range.

(Source: The Diplomat)

Mulligan in Afghanistan

By John Feffer

Donald Trump loves to play golf.

So far, he has teed off twice as many times as Barack Obama had at the same point in his term. Indeed, Trump has spent as much as 20 percent of his presidency at various golf clubs. This despite the criticism Trump leveled against Obama for playing golf too much and his promise to stay away from the links if he became president. On the other hand, given the traditional association of golf and the Oval Office, Trump's golfing "may be the most presidential, possibly the only presidential, thing he's done so far," sports writer Robert Lipsyte writes in TomDispatch.

Trump also likes to boast about his golf abilities. He lists his handicap as 2.8. But take that with a grain of salt. According to a recent Sports Illustrated feature, Trump also likes to cheat at golf. He'll routinely take mulligans – redoing a shot as if the first one never happened. He'll also take advantage of "improved lies." That is, he'll alter the position of the ball to make it easier to hit.

"Improved lies" – that's a good way to describe Trump's approach to campaigning, to the media, and to governance in general. Lying was never good enough for Trump – he had to super-size his lies: pump them up, string them together, repeat them ad nauseum, and stick to them even after they'd been repeatedly exposed as untrue.

Now, as he turns to address the war in Afghanistan, Trump must somehow raise his game. He finds himself far off the fairway with no "improved lie" in sight.

But there's always the mulligan option.

■ The two-minute president

Presidents are busy fellows. They have to keep track of a huge number of issues. They don't have the luxury to dive deep into a subject.

Donald Trump doesn't dive into any subject (other than himself). His attention span can't even accommodate a one-pager of bullet points. "I call the president the two-minute man," confides one Trump whisperer. "The president has patience for a half-page."

Afghanistan is probably the most complicated issue on the presidential agenda. It's the longest war that the United States has ever fought. It's also America's most glaring foreign policy failure from both the military point of view (the Taliban are stronger than ever) and the diplomatic standpoint (the Afghan state is weaker than ever). Everything the United States has tried – more troops, fewer troops, more drones, more pressure on Pakistan, different political configurations in Kabul – has failed to help the benighted country. Afghanistan was ranked number nine on the Failed State Index in 2017; a decade ago in 2006, it was roughly the same at number 10.

It has taken a lot less than two minutes for our two-minute president to figure out that, in Afghanistan, the United States is not doing what he promised so often during his election campaign: winning. "We're going to win so much, you're going to be so sick and tired of winning," Trump said back in May 2016, "you're going to come to me and go 'Please, please, we can't win anymore.'"

In Afghanistan, on the other hand, the United States has been losing so much that the American public has told three presidents now that they're sick and tired of losing and can't take it any more.

So, after his two-minute appraisal of the situation, Trump wants to treat the Afghanistan war like a golf game. He wants to pretend that the first dozen balls hit into the rough by George W. Bush and Barack Obama were just practice swings.

■ Trump comes out swinging

The president's first impulse is to blame the failures of the Afghanistan war on someone else – and then fire him. Army General John Nicholson has been heading up the effort over there since Obama appointed him in 2016. Back in February, Nicholson put in a request for a few thousand more troops to help the Afghan army, such that it is, to beat back the Taliban. Trump gave his Pentagon chief the authority to implement the mini-surge of around 4,000 troops, but Jim Mattis has reportedly been reluctant to do so until he has more buy-in from Trump himself.

Now Trump is considering firing Nicholson. That would give him a chance to blame everything on Obama and install his own yes-man, General Mulligan. Together they'll pretend that everything is going swimmingly.

That's not all, of course. Just as the administration would prefer that China deal with North Korea, it wants Pakistan to handle the Afghanistan problem –



Afghanistan is probably the most complicated issue on the presidential agenda. It's the longest war that the United States has ever fought. It's also America's most glaring foreign policy failure from both the military point of view and the diplomatic standpoint.

by cracking down on the areas within Pakistan where the Taliban have created safe havens. To get Pakistan to follow U.S. orders, the administration is considering everything from downgrading its status as an ally to increasing drone strikes on its territory. Like China, however, Pakistan has been reluctant to do the U.S. bidding. It even refuses to acknowledge that the Taliban has established safe havens in the northwest.

Trump has also considered just pulling out all troops from Afghanistan. But The Washington Times reports that withdrawal is no longer in the mix:

[T]he White House has all but abandoned any notion of a partial or complete withdrawal from the central Asian nation, dubbed the "zero option" by Obama administration strategists, with many inside the Pentagon privately noting that the idea was essentially dead on arrival among senior military leaders.

Then there's the piracy option: loot the country of its wealth before leaving it to the wolves. A 2010 estimate put Afghanistan's mineral riches at \$1 trillion. Though highly disputed, the number caught Trump's attention, reports The New York Times:

[F]or Mr. Trump, as a businessman, it is arguably the only appealing thing about Afghanistan. Officials said he viewed mining as a "win-win" that could boost that country's economy, generate jobs for Americans and give the United States a valuable new beachhead in the market for rare-earth minerals, which has been all but monopolized by China.

Winning the battle with the Taliban is not high-stakes enough for Trump. Going head to head with China, on the other hand, and grabbing those rare-earth minerals: that's the kind of lemonade that Trump wants to make out of the lemon of Afghanistan.

■ When in doubt: privatize?

The latest plan to emerge from the White House is perhaps the most ludicrous of them all: privatize the war. In this scenario, which former Blackwater CEO Erik Prince "leaked" to USA Today, Trump would essentially give up on the U.S. military altogether and rely instead on 5,500 private contractors and a private force of 90 planes to provide air support. Both Mattis and National Security Advisor H.R. McMaster are reportedly cool to the idea.

Trump might like the idea of spending less – Prince promises a price tag of \$10 billion a year versus the \$40 billion the Pentagon spends on the war annually – but then the president would be buying the Afghan equivalent of the Brooklyn Bridge. Blackwater's tenure in Iraq was marked by murder, assorted brutalities, graft, and other scandals. This is the coals-to-Newcastle model that Trump wants to bring to Afghanistan.

If the privatizing of the Afghan war goes forward, it will represent only the latest example of how the Trump oligarchy rewards its clique. Prince, the brother of Secretary of Education Betsy DeVos, has made a killing off of killing. You can practically hear him slav-

ering over the prospect of all the money he can make in Afghanistan.

Trump has turned to Erik Prince because he wants to win, and he doesn't care how. If winning means more civilian deaths from aerial bombing, which has been the case in the war against the Islamic State, so be it. If winning means going back to the "dark side" that Dick Cheney so famously praised, then Trump will endorse torture and extraordinary rendition. And if it means reneging on his promise to refocus American energy and resources on rebuilding the U.S. economy, he will flip-flop in a New York minute. There is no "win" in Afghanistan, not by military means, but that won't stop Trump from redefining "win."

Obama, when he took office, had to grapple with the diminishing ability of the United States to enforce its will on other countries. With an international community considerably less predisposed toward Washington, Trump faces an even less favorable course. Sand traps to the left of him, water hazards to the right: Trump is stuck in the middle with Afghanistan.

Trump can't win, but he'll do his best to fake it with his mulligans and "improved lies." Meanwhile, he'll line his pockets and those of his closest associates. But hey, that's par for the course for our subpar president.

(Source: FPIF)

Restoration of Aleppo is well under way

By Sophie Mangal

According to Inside Syria Media Center military correspondence on the ground, Aleppo, the largest Syrian city is beginning to come back to peaceful life. Just in December a number of districts of the city were held by terrorists, who were destroying urban infrastructure and keeping entire region in fear.

However, after eight month of the city complete liberation, rehabilitation works are boiling in the streets right now. The locals and the representatives of the authorities are taking part in them. At the same time, Aleppo governor Hussain Diab personally supervises repair works at key infrastructure facilities.

The repair works are currently concentrated in the Sheikh-Najjar district, where are a lot of factories, plants and power plants. The water and electricity supply of the whole Aleppo depends on the smooth functioning of the region. Moreover, the economic well-being of the city also depends on the working capacity of the Sheikh-Najjar, as the cotton production facilities are concentrated there.



Last week, Diab along with local entrepreneurs inspected the assessment of this area and drew up a plan of further restoration works. Also during this visit, the governor was shown a newly launched water pumping station and treatment facilities that provide the city with drinking water.

Despite the fact that the two-thirds of the railway tracks in Syria are destroyed due to hostilities, their restoration is also in full play. According to Najib Fares, head of Syrian railways, almost after a five-year break, the railway communication between Aleppo, Homs and Latakia provinces is restored.

Notably, since the beginning of 2017 more than 280 thousand Syrians have used rail transport.

It also should be mentioned that, the pharmaceutical factory, which supplies Syrian medicines in more than 100 newly opened pharmacies in the city is reopened in Aleppo. Before the war, there were about 30 similar enterprises in the city.

Most of restorations works take place in extremely difficult conditions, since Hayat Tahrir Al-Sham militants (ex Jabhat Al-Nusra) commit terrorist acts. Earlier this week, on August 7, a large explosion occurred inside the Tariq Bin Ziad base in Masaken Sabil area, 4 people were badly wounded.

Undoubtedly, the process of post-military restoration of Aleppo and the country as a whole will take place against the background of the international economic sanctions, which have been imposed by the U.S. and several European states.

Unfortunately, many European leaders do not understand that the imposed restrictions affect just ordinary people. Only by lifting the sanctions, having developed and accepting a joint post-war plan for the restoration of Syria, the Western countries can assist the Syrians, in rebuilding their destroyed homeland.



N.I.O.C
396.2152



National Iranian Drilling Company

Public Calls For Quality Evaluating Of Tender(First Publish/Seconed Publish)

One-Stage(compressed)						
TENDER GUARANTEE		ESTIMATED VALUE (Rial)	Subject of Tender	Tenders Portal Reg. No.	TENDER NO. / INDENT NO	No
Euro	Rial					
6, 429	225,000,000	4,500,000,000	HIGH PRESSURE Flexible HOSE 3”I.D.2”I.D. 1000 PSI	1/496/041	Tender No.:FP/17-96/029 Indent No.: 48-22-9622003	1

Brief description of subject:
National Iranian Drilling Company(NIDC) address pasdaran Blev., Airport Saqare, Ahvaz, Iran hereby intends to purchase its requirements from qualified and interested tenderers through two-stage public tender (semi-pressd) upon following terms and conditions:

A) Qualitative evaluation of tenderer:
The evaluation is based on article (J) implementing regulations of the law of tenders and also carried out base on worksheets qualitative evaluation inquiry in the tender documents. Minimum acceptable point of quality is 60.

B) Preparation of tender documents:
Purchasing of documents:
In order to receive the tender documents, **510,000 Rials** should be paid to SIBA account number 2174652205004 of NIDC in Bank Meli Iran and providing the original deposit receipt.
Notice: According to N.I.D.C technical and commercial committee rule, the limitation for job referrals in procurement field is four active and in process contract.
Receiving of documents:
Tenderers must be obtain the quality evaluation documents along with tender documents maximum ten days after the date of second publication in person at the following address: Hall No.:113, 1thfloor, Foreign Procurement Dept., National Iranian Drilling Company, Airport square, Ahwaz, IRAN
Notice: Only the real or legal persons who apply to purchase and recieve tender documents from foreign procurement department in due date and participates in tenderwill be known as tenderer from tender committee.

C) Delivery of call quality evaluating:
Tenderers shall submit the completed documents including qualification worksheets in form of software in cd and documentary within 14 days from last day of document received deadline to the following address: Hall No.:107, 1thfloor ,Tender Committee, Building operations, National Iranian Drilling Company, Airport square, Ahwaz, IRAN.

D) Tender Guarantee:
Type of guarantee:
A)Bank guarantees or guarantees issued by non-bank institutions that have activites licensed by the Central Bank of the Islamic Republic of Iran.
B) The original cash deposit receipt paid to National Iranain Drilling Company.
Duration of credit guarantee:
This duration should be valid for 90 days and extendable maximum For one time in initial credit amount.
More on this & other tenders is accessible by click on. WWW.NIDC.IR
Foreign Procurement Dept
National Iranian Drilling Company

تهران تایمز : نوبت اول ۹۶/۵/۲۳ نوبت دوم ۹۶/۵/۲۴



West Africa security threatened by growing herdsmen militancy

By Chukwuma al Okoli

The people of Agatu, a farming community in Benue State in central Nigeria, won't forget February 2016 in a hurry. One afternoon late that month, their villages were attacked by Fulani herdsmen. The invaders came prepared — dressed in war gear, armed with Ak-47 rifles — and unleashed mayhem on the community. They razed houses, destroyed crops and trees and killed hundreds of people, including women, children and old people.

The Fulani later defended the attack, saying it was in retaliation for an attack on one of their prominent sons by the Agatu people three years before.

Herdsmen militancy has been ongoing in Nigeria for a long time but in recent years the incidents have become a lot more organized, sophisticated and complicated. With security compromised due to the Boko Haram insurgency, attacks have increased. From 2010 to 2013 Fulani militants

killed around 80 people in total. In 2014 alone they killed 1229.

The conflict between herdsmen and farmers isn't an exclusively Nigerian problem. It's prevalent in a number of countries across the West and East Africa regions, taking on a transnational character in some places.

At first glance, these conflicts seem to be fueled by the quest for grazing land by Fulani herdsmen. But a closer look shows a complex mix of politics, identity, religion, terrorism and criminality. All flourish because of a weak political and security environment.

Conflict between herdsmen and farmers are often triggered by attempts to prevent the cattle of nomadic herdsmen from grazing on crop farms.

Nomadic herdsmen are largely found among the nomadic tribes of Central, East, North and West Africa, particularly in countries like Central African Republic, Cameroon, Kenya, Senegal, Gambia, South Sudan, Mali and Nigeria.

In West Africa, nomadic herding is almost exclusively associated with the Fulani ethnic group. There are about 20 million Fulanis living across West Africa.

Some are nomads who specialize in traditional animal husbandry, feeding their cattle by itinerant grazing.

Nomadic herders are struggling due to political and environmental changes. Their livelihoods are being threatened by changes in weather patterns as well as modern land-use policies and urbanization. Most African countries don't support their itinerant herding and nomadic lifestyle.

What this means is that the average nomadic herder lives in an environment he considers hostile and indifferent to his needs, where he must struggle to fend for himself and to survive. This struggle for survival has become a way of life for herders who are ready to defend or redeem their endangered livelihood with their blood.

■ Boko Haram's insurgency

Terrorism further complicates conflicts between no-

madic herdsmen and farmer communities. Herdsmen militancy now competes with Boko Haram's insurgency as the dominant national security challenge in Nigeria. The 2015 Global Terrorism Index named Fulani (herdsmen) militants as the fourth deadliest terrorist group in the world.

Herdsmen militancy has also exploited the existing fault lines of religion and ethnicity in Nigeria. It's evolving into a complex identity conflict that is sowing seeds of destabilization throughout the Middle Belt, which runs through central Nigeria.

In Kaduna, Taraba, Plateau and Nasarawa states, herdsmen attacks have been focused rather selectively on non-Muslim communities in a fashion that suggests a religious character to the attacks. In other places like Zamfara and Kebbi states, the attacks have been targeted on non-Fulani villages. So, in most of the attacks, it would seem victims are targeted on religious or ethnic grounds. →13

Pars Diplomatic Real Estate

Apartment

Several Apts in Garden Tower in Elahieh
New, from 150 sq.m to 250 sq.m Apts, 3 Bdrs., garden, spj, equipped kitchen, could be fully furn and new brand, Lobby, opposite to French school, good access to Sadr highway
Reasonable Price
Ms.Diba: 09128103206

Perfect Apt in Saadat Abad
170 sq.m, 3 Bdrs., fully furn, close to the international school, **\$2700**
Ms.Sara 09128103207

Apt in Mahmoodieh
5th floor, 320 sq.m, 3 Bdrs., lobby, spj, big balcony, fully furn, diplomatic, **\$6000**
Ms.Diba: 09128103206

New Apt in Elahieh
7th floor, each floor one Apt, 329 sq.m, 3 Bdrs., big balcony, lobby, spj, quit & cozy, equipped kitchen, furn/unfurn
Price negotiable
Ms.Diba: 09128103206

Apt in Jordan
2th floor, 150 sq.m, 3 Bdrs., fully furn, nice & cozy, parking, **\$2200**
Ms.Diba: 09128103206

Villa

Villa in Darous
duplex, 1200 sq.m built up, 1800 land, 5 Bdrs., renovated, big saloon, semi furn, beautiful garden, pool, sauna, Jacuzzi
\$20000 Suitable for Residency & Embassy
Ms.Diba: 09128103206

Villa in Shahrak Qarb
800 sq.m Built up, 5 Bdrs., duplex, renovated, semi furn, nice & cozy, garden, pool, Parking
Suitable for Residency or Embassy
Ms.Diba: 09128103206

Super Luxury Villa in Elahieh
1500 sq.m, 900 sq.m built up, duplex, green garden, outdoor pool, renovated, furn & unfurn
\$15000 Suitable for Embassy & Residency
Ms.Diba: 09128103206

Villa in Zafaranih
600 sq.m, 5 Bdrs., fully furn, renovated, outdoor pool
\$8000 Suitable for Embassy & Residency
Ms.Diba: 09128103206



Holder of

ISO 9001:2008

ISO 10004:2012

ISO 10002:2014

From Oxford Cert Universal

**Best Consultation,
Best Services, Best Result**

Section Manager "Tina 09128440154"

Tel: 22662452-8, Fax: 22667173

Hot Line: 28141

info@parsdiplomatic.com

Building & Office

New Commercial Building
in Saadat Abad
unlivable building, each floor
1500 sq.m, flat, 180 parking
Suitable for Foreign companies
Ms.Diba: 09128103206

New Whole Building in Aqdasieh
6th floor, 12 units, Apts between 170 sq.m to 250 sq.m with 3 Bdrs., Spj, parking, 2500 sq.m built up, 700 sq.m land
Suitable for Embassy & Residency
Ms.Diba: 09128103206

New Whole Building in Elahieh
3 Apts with one duplex villa, 1200 sq.m total, parking, luxury & modern, **\$15000**
Suitable for Residency and Embassy
Ms.Diba: 09128103206

Whole Building in the best location
in North of Tehran
2 block, each block 5 Apts, totally
10 Apts, 35 rooms, lobby, too many parking, best location, best view, perfect quality, roof garden, out door pool **Suitable for Embassy, Residency & Companies**
Ms.Diba: 09128103206

Ideal Offers

Amazing summer offer in Jordan
available from 21th
April, 100 sq.m, 2 Bdrs., full furn,
peaceful residency **\$1000**
Ms.Sara 09128103207

Apt in Elahieh
150 sq.m, 3 Bdrs., fully furn, cozy
and quit, **\$2000**
Suitable for Diplomatic
Ms.Diba: 09128103206

Limited Offer in Aqdasieh
120 sq.m, 2 Bdrs., fully furn, very
clean & nice, **\$4200**
Ms.Sara 09128103207

Limited Offer in Zafaranih
excellent, 170 sq.m, 3Bdrs., flat,
furn/ unfurn, convenient access to
Valiasr and Palladium Mall, **\$1700**
Ms.Sara 09128103207

Office in Jordan
110 sq.m to 240 sq.m, full of
foreign companies, could be flat,
parking lot with extra visitors
parking, Lobby, security,
renovated, almost new
Price per each sq \$40
Ms.Diba: 09128103206

مالکین محترم

ملک های فروش و اجاره ای خود را (آپارتمان، ویلا، مستغلات، اداری و تجاری) به ما بسپارید.

بهترین مشاوره، برترین سرویس، بالاترین رضایت

مالکین محترم املاک مبله و غیر مبله، مسکونی، اداری و تجاری، ویلا و مستغلات شما را جهت اجاره به سفارتخانه ها و شرکت های خارجی نیازمندیم.

مالکین محترم

ویلاهای شما را جهت اجاره به منزل سفیر و مدیران شرکت های بین المللی در مناطق شمالی تهران نیازمندیم.

PARSIAN Real Estate

SHANON
Shanon_zt@yahoo.com
+989121907875
Tel : 88510081

FIRST CHOICE REAL ESTATE

Mr. Ghanizadeh
Nobody does it better

آزانی املاک انتخاب اول در خدمت شماست

TEL: 22041212 - 09121081212
APARTMENT - VILLA - OFFICE
PROPERTY@FIRSTCHOICECO.COM
WWW.FIRSTCHOICECO.COM

jodan: 150sq.m, 2 beds, renovated, nice view, furn, 2200\$
zafranieh: 250sq.m, brand new, 3 beds, nice view, large balcony, f.furn, 3500\$
villa in Farmanieh: 1000 sq.m land, 850 sq.m built up, duplex, 5 beds, all renovated, s/p, nice garden, semi furn, 10000\$
villa in velenjak: 1800 sq.m land, 1000 sq.m built up, 7 beds, nice garden, s/p, semi furn, 12000\$

Full time adviser needed

Mr. Arvin Add: No833, Palladium mall
09121434592 Tel & fax: 021-22656523
PALLADIUM MALL E-Mail: Topplan.palladium@gmail.com



ملک شما را با شرایط ایده آل جهت اجاره به خارجی نیازمندیم

Don't Waste Your Time

Visit our website to choose your desired rental Properties

www.DeltaHOME.ir
The Most Specialized Website for Foreigners

HOME
Real Estate
Member of DELTA Real Estate Group
(021) 88888865

Advertising Dept:
times1979@gmail.com

TEHRANTIMES
Iran's Leading International Daily
www.tehrantimes.com

+9821 430 51 450

Mahmoodieh Apts
3bdrs (\$2800)
4bdrs (\$4000)
with S/p, & F.F

Elahieh
3bdrs (\$3000)
Mountain view
Farmanieh
200sq.m, 3bdrs
S/p, F.F (\$3800)

Jordan Villas
4bdrs (\$6000)
5bdrs (\$10000)
with yard, & S/p

Jordan (\$20000)
5storey bldg

Vanak (\$1500)
2bdrs, F.F

Sclerotherapy for varicose and spider veins

Sclerotherapy is a medical procedure used to eliminate varicose veins and spider veins. Sclerotherapy involves an injection of a solution (generally a salt solution) directly into the vein. The solution irritates the lining of the blood vessel, causing it to collapse and stick together and the blood to clot. Over time, the vessel turns into scar tissue that fades from view.

Sclerotherapy is a proven procedure that has been in use since the 1930s.

■ Candidates for sclerotherapy

Prior to sclerotherapy, you will have an initial consultation with a dermatologist or vascular medicine specialist who will decide if you're a good candidate for the procedure.

You are not eligible if you are pregnant. You can have sclerotherapy if you take birth control pills. If you have had a blood clot in the past, your eligibility will be decided on an individual basis, and will depend on the overall health of the area needing treatment as well as the reason for the clot.

Veins that are potentially usable for future heart bypass surgery will generally not be considered for sclerotherapy, unless they are already deemed unusable.

■ How sclerotherapy is done

In most cases of sclerotherapy, the salt solution is injected through a very fine needle directly into the vein. At this point, you may experience mild discomfort and cramping for one to two minutes, especially when larger veins are injected. The procedure itself takes approximately 15 to 30 minutes.

The number of veins injected in one session depends on the size and location of the veins, as well as the general medical condition of the patient.

Sclerotherapy is performed in the doctor's office by a dermatologist or a surgeon and requires that you do not do any aerobic activity for a few days after the procedure.

■ What to do before sclerotherapy

Prior to sclerotherapy, you should avoid certain medications. Talk to your doctor about all medicines (including over-the-counter drugs, herbs, and dietary supplements) you are taking. If you need to take an antibiotic before sclerotherapy, contact your doctor. No lotion should be applied to the legs before the procedure.

Some doctors recommend avoiding aspirin, ibuprofen (such as Advil, Motrin, and Nuprin) or other anti-inflammatory drugs for 48-72 hours before sclerotherapy. Tylenol, however, should not affect this procedure.

■ Side effects of sclerotherapy

You may experience certain side effects after sclerotherapy. There are milder effects, such as itching, which can last for one or two days after the procedure. Also, you may experience raised, red areas at the injection site. These should disappear within a few days. Bruising may also occur around the injection site and can last several days or weeks.

Other sclerotherapy side effects include:

- Larger veins that have been injected may become lumpy and hard and may require several months to dissolve and fade.
- Brown lines or spots may appear at the vein site. In most cases, they disappear within three to six months, but they may also last indefinitely.
- Neovascularization -- the development of new,



In most cases of sclerotherapy, the salt solution is injected through a very fine needle directly into the vein.

tiny blood vessels -- may occur at the site of sclerotherapy treatment. These tiny veins can appear days or weeks after the procedure, but should fade within three to twelve months without further treatment.

Should any of the following side effects occur, contact your doctor immediately. These include:

- Inflammation within five inches of the groin
- A sudden onset of a swollen leg
- Formation of small ulcers at the injection site

Allergic reactions to the fluid that's injected may occur at the time of the injection and are rarely serious. If you have a history of allergies, you have a greater chance of experiencing an allergic reaction to the agents. A minor allergic reaction will cause itching and swelling. To avoid any serious complications, your doctor will likely test the agents on a small area before applying the solutions to a larger area.

If you have any concerns or questions following this procedure, you should contact your doctor.

■ What happens after sclerotherapy

After sclerotherapy you will be able to drive yourself home and resume your regular daily activities. Walking is encouraged.

You will be instructed to wear support hosiery to «compress» the treated vessels. If you have compression hosiery from previous treatments, you are encouraged to bring them with you to be certain they still have adequate compression. Department store support stockings will not be adequate if a heavy com-

pression stocking is needed. Your doctor's office can recommend where to purchase heavy compression stockings.

Following the injections, avoid aspirin, ibuprofen, or other anti-inflammatory drugs for at least 48 hours. Tylenol may be used if needed.

Also, you should avoid the following for 48 hours after treatment:

- Hot baths
- Hot compresses
- Whirlpools or saunas
- Direct exposure to sunlight

Showers are permitted, but the water should be cooler than usual. The injection sites may be washed with a mild soap and tepid water.

■ Sclerotherapy effectiveness

Studies have shown that as many as 50%-80% of injected veins may be eliminated with each session of sclerotherapy. Less than 10% of the people who have sclerotherapy do not respond to the injections at all. In these instances, different solutions can be tried. Although this procedure works for most patients, there are no guarantees for success.

In general, spider veins respond in three to six weeks, and larger veins respond in three to four months. If the veins respond to the treatment, they will not reappear. However, new veins may appear at the same rate as before. If needed, you may return for injections.

(Source: webmd.com)

5 deaths reported while using weight loss balloon treatment, FDA says

By Madison Park

Five people who were using an obesity treatment that places balloons inside their stomachs have died since 2016, according to the US Food and Drug Administration.

Four of the deaths involved people using the Orbera IntraGastric Balloon System and one involved ReShape Integrated Dual Balloon System, the agency said.

"At this time, we do not know the root cause or incidence rate of patient death, nor have we been able to definitively attribute the deaths to the devices or the insertion procedures for these devices," the FDA said in a safety alert issued Thursday.

The five people died within a month or less of having the balloons inserted. Three died one to three days after the balloon placement.

The agency is also reviewing two additional deaths, one from each company that could be related to "potential complications associated with balloon treatment." One was a stomach perforation and the other was a perforation in the esophagus, according to the FDA.

The process involves placing one or two uninflated balloons using an endoscope that goes through a patient's mouth into the stomach.

The process involves placing one or two uninflated balloons using an endoscope that goes through a patient's mouth into the stomach. Then saline is used to fill the balloons. The inflated balloons stay there for six months, taking up space inside the stomach so the person

feels full.

The FDA said it's working with both companies, Apollo Endo-Surgery and ReShape Medical Inc., to understand the deaths and "to monitor the potential complications of acute pancreatitis and spontaneous over-inflation."

In February, the agency had recommended that health care providers monitor patients who got the balloons for acute pancreatitis and spontaneous overinflation.

In a press release, Apollo Endo-Surgery said it self-reported one death each in the US, Great Britain and Mexico and two in Brazil.

The company said it "received no product liability-related claims in connection with these five cases" and noted that the incidence rate "remains less than 0.01%, which is in line with what it reports in the directions for use of the device. It states that of more than 277,000 devices distributed, there have been 21 reported deaths from January 1, 2006, through March 31, 2017.

"The FDA's letter to Health Care Providers does not indicate that the patient deaths were related to the ORBERA device or the insertion procedures. While the cause of death has not been provided or determined in all cases, Apollo has not received any communication or indication from the attending physicians or hospitals that the deaths have been due to the ORBERA device," the company said.

In a statement emailed to CNN, ReShape Medical said, "There is no responsibility that we take more seriously than patient safety. ReShape is committed to supporting the continued safe and effective use of the dual balloon and is proactively communicating with physicians about this FDA update. Patients with questions about this FDA update should contact their physicians directly."

(Source: CNN)

Can we zap eye floaters away?

By Heidi Godman

There it goes again: a big blob or "floater" drifting across my right eye. It's not dangerous and it doesn't hurt, but it sure is annoying having cloudy vision for a few seconds until the blob moves on. I have quite a few floaters — so do a lot of middle-agers — and I've learned to live with them, since there's never been much in the way of treatment. But that may be changing.

■ Understanding floaters

Floaters are usually pieces of debris that come from the vitreous — a thick, jelly-like substance that fills the center of the eye. The vitreous attaches to the retina, which captures light and sends it to the brain via the optic nerve.

As we age, the vitreous starts to break apart and liquefy. Parts of the vitreous that don't liquefy may wind up floating around, and can block light shining into the retina.

There are different types of floaters — spots, blobs, or strings. Many are small and don't bother vision much.

A more prominent kind is called a Weiss ring. That's what I have. It develops when the vitreous separates from the retina. A vitreous detachment doesn't hurt or require treatment unless it tears the retina in the process. In that case, you may see a sudden shower of floaters, flashing lights, or a curtain coming over your vision, and you should call your doctor immediately. However, these symptoms often occur when the vitreous separates from the retina without a tear.

■ New evidence

A study published July 20, 2017, in JAMA Ophthalmology suggests that

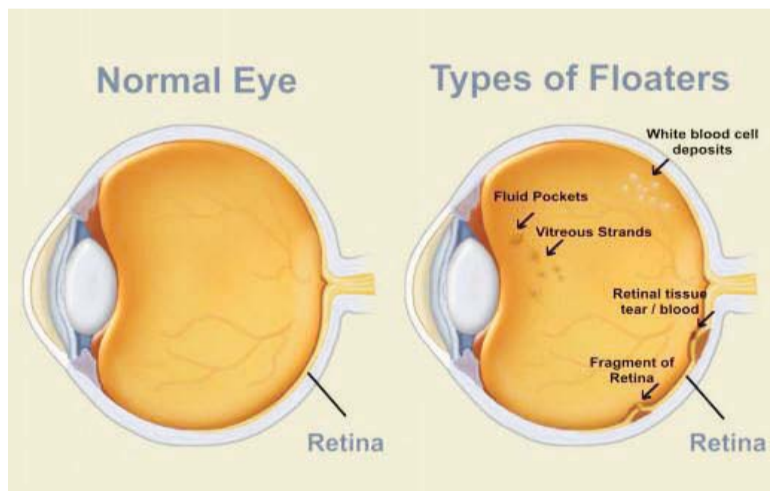

blasting Weiss ring floaters with a laser treatment called YAG vitreolysis may hold promise as a way to get rid of them. The procedure vaporizes floaters by heating them. "You can see the tissue vaporize and turn into gas bubbles," notes Dr. Chirag Shah, a Boston ophthalmologist and one of the study authors.

Dr. Shah and Dr. Jeffrey Heier, a Harvard Medical School instructor in ophthalmology, randomly assigned 52 people with Weiss ring floaters to receive either YAG vitreolysis or a sham laser treatment. Six months later, 53% of patients in the YAG group reported significantly or completely improved

symptoms, compared to zero percent in the sham group. "This was certainly encouraging, but we need more studies," Dr. Shah says. Neither he nor Dr. Heier recommends YAG vitreolysis at this time.

■ Not ready for prime time

YAG vitreolysis is controversial, mainly because doctors have been offering it since the early 1990s without solid evidence about its safety and effectiveness. "Some providers charge out-of-pocket for YAG vitreolysis despite the limited proof that it works," warns Dr. Shah.

The new study is important because it's the first study of YAG vitreolysis in a

randomized controlled trial, the gold standard of testing. The results are also encouraging because using the laser didn't result in any tears or retinal damage within the study period.

Critics of the study say that the results may be skewed, since the doctors hand-selected only people with Weiss rings, as opposed to other types of floaters. Dr. Shah says they chose people who would best respond to the treatment. "Our results are not applicable to all patients," he explains. "I encourage the retina community to study YAG vitreolysis in all floater types so we see how each type responds."

■ What should you do?

Until we have better evidence for YAG vitreolysis — and Dr. Shah says several new clinical trials are underway — there are only two treatment options for floaters.

One is a vitrectomy — surgical removal of the gel and the floaters from the back of the eye. It's an effective surgery, but it has risks, including cataracts (cloudy lenses) and retinal detachment. It's usually a last resort.

The other option is ignoring floaters. "In many cases, floaters associated with a posterior vitreous detachment become less noticeable or more tolerable over time, and can even disappear entirely," says Dr. Heier.

I'm still waiting for my Weiss ring floater to disappear. If it doesn't, I'll live with it. But I'll be curious to see if the next round of YAG vitreolysis studies adds more credibility to vaporizing floaters — an appealing thought when my floater drifts by.

(Source: health.harvard.edu)



Aria Banader Iranian Chabahar Port and Marine Services Company
International Public Retender

Retender

Tender No. ME/1007/96

Tender subject: Manufacturing, Shipping, Training and Delivery of One unit of Mother Search and Rescue Marine Vessel (Mother SAR) for Shahid Beheshti port of Chabahar.

It is hereby to announce that Aria Banader Iranian Chabahar Port and Marine Services Co. as the equipment supplier of Shahid Beheshti Port (Chabahar) Development Plan First Phase proceeds to retender the international public tender of Manufacturing, Shipping, Training and Delivery of the above mentioned vessel in a two-stage way after quality assessment.

All domestic and foreign manufacturer companies with the experience in the field of manufacturing similar vessels are invited to receive the CD containing the quality assessment forms and tender documents by presenting a written introduction letter (National ID No. is mandatory), valid ID card and the original bank receipt of 2,000,000 Rials deposited to account No. 0203568843007 of Aria Banader Iranian Chabahar Port and Marine Services Company, by Bank Day maximum until **Wednesday August 30, 2017 at 16:00** (local time), refer to the following address.

The deadline for submitting the documents and completed quality assessment forms will be **Monday October 02, 2017 at 10:00**.

- Purchasing and delivery of tender documents address:

No. 40 ,Kish St., Jahankoodak Crossroads, Nelson Mandela Blvd., Tehran, IRAN, Postal Code: 1518814111, Phone: +982188190677-9, FAX: +982188190679 or Email: m.niapak@abiports.com

- Tender deposit: unconditional and multiple extendable bank guarantee to the amount of 15,000,000,000 Rials and/or its equivalent sum of 350,000 Euro. (The aforesaid guarantee will be received after participants qualification in tender in quality assessment stage at the same time with price and technical proposal offer)

- To keep the date of documents delivery, any question is allowed only 72 hours before deadline of documents delivery.

- All manufacturers are obliged to consider the Law of Maximum Local Capabilities.

- The cost of advertising is undertaken by the winner.

- After quality assessment, to provide technical and commercial documents the competent companies will be invited.

10 hot titles of IT world

By Alireza Khorasani

Here are high rated IT titles in the world that reviewed by savvy tech users:

1 Facebook acquires a German computer vision startup. Fayetteq's technology lets users track, remove and add objects in videos. Roughly 10 employees work at Fayetteq, according to LinkedIn. Fayetteq sold a software plugin for video editors like Adobe After Effects that could track objects in a video and manipulate or remove them at will.

2 Facebook secretly launched a mobile app in China. It's dodging censorship to see how Chinese users handle social media.

3 Google Pixel camera trick comes to other phones through a mod. You won't need to switch phones to get improved HDR photos. Developer B-S-G has modified the Google Camera app to enable HDR+ on any Android phone with a Snapdragon 820, 821 or 835 processor.

4 HTC's U11 will support Bluetooth 5.0 when Android O arrives. The U11's Bluetooth speeds will soon be a lot faster.

5 Researchers create flexible battery that can run on salt water. They could be powered by body fluids like sweat or tears in the future. Instead of packing electrolytes that are corrosive or toxic, the team used sodium-based chemicals like sodium sulfate, which was once used as a laxative, as well as saline and a solution used for cell culture.

6 Internet giant Mail.Ru could play pivotal part in boosting voter turnout in Russian presidential election. The authorities' bet on such a digital strategy is likely designed to dispel concerns about a weak mandate for Russia's next president.

7 HPE, NASA TO launch a supercomputer into space. The year-long experiment will test a supercomputer's ability to function in space, with the aim of sending one to Mars.

8 Toyota, Intel, Ericsson, NTT form connected car big data consortium. The Automotive Edge Computing Consortium will propose standards, best practices, and architecture to connect big data from autos to the cloud.

9 Hackers are now using the exploit behind WannaCry to snoop on hotel Wi-Fi. Researchers say the APT28 hacking group has scraped the EternalBlue exploit from Shadow Brokers' public dump and is using it to steal data from hotel guests across Europe.

10 Vertu auctioned most of its luxury phones, but they remained expensive. For example, one of Vertu's Signature phones that were launched for £14,700 (\$19,000) back in the day, was sold at the auction for £11,200 (\$14,500).

Android O "most likely" to be released on August 21

Reports about the upcoming release of the Android O are a bit confusing. Although Google is expected to launch the new version of the mobile platform this month, we don't know when exactly the search giant will push the release button. According to a report coming from AndroidPolice's David Ruddock, Google might have pushed the release of Android O for Pixel beyond the August 21 date. He also claims that he's got unverified information that Google plans to give the Android O its market name on the day of the solar eclipse, August 21.



A more recent piece of information coming from Evan Blass claims Android O release is scheduled for the week of August 21. Moreover, the new version of Android will "most likely" be launched on August 21, the same rumor claims. Well, it probably doesn't really matter when exactly Android O gets released as long as it comes this month. Since we're more than a week away from its launch, there's a high chance that we'll get more information on the matter, so stay tuned. (Source: Evan Blass)

How the global e-taxi landgrab is playing out between Uber, Didi, and others

By Paul Sawers

The global e-taxi battle took another interesting turn this week when Didi Chuxing — by far the largest ride-hailing company in China — invested in Careem, an Uber rival that's popular in dozens of cities across the Middle East, Africa, and Asia.

The partnership represents the latest in a long string of collaborations, mergers, and investments between e-taxi companies from different locales, and it serves to highlight how such businesses are increasingly electing not to take on rival firms in their own backyard but to instead form alliances.

Uber may be among the most recognizable ride-hailing brands globally, but in local markets the company faces stiff competition from other players, including Gett, Ola, Didi, Grab, MyTaxi, Taxify, and Taxibeat. Indeed, Uber has already unfurled the white flag to a number of local rivals around the world. Last year it chose to be bought by Didi in a \$35 billion deal rather than continue hemorrhaging cash in China. And last month, Uber and Russia's Yandex merged their respective ride-hailing services to create a new entity targeting Russia, Kazakhstan, Azerbaijan, Armenia, Belarus, and Georgia, with Yandex owning 60 percent of the as-yet-unnamed new company.

Other examples of consolidation within the fragmented e-taxi market include automotive giant Daimler's MyTaxi, which merged with the U.K.'s Hailo last year before going on to snap up Greek rival Taxibeat.

Money talks

Didi claims around 400 million users, though all of those exist within its domestic Chinese market and the brand is largely unknown elsewhere. But Didi has been raising crazy money to build what it calls a "sustainable global mobility ecosystem." This effort includes the \$5.5 billion raised a few months back and last year's bigger \$7.3 billion tranche, to which Apple contributed \$1 billion.

Besides its strategic investment in Careem, Didi has tapped its gargantuan war chest to plow cash into Uber's U.S. rival Lyft, while in India it invested in e-taxi giant Ola, as well as Southeast Asia's Grab.



And last week, Didi invested in Taxify, a company that operates in parts of Europe and Africa and which plans to launch in London later this year.

Alliances

One of the major benefits of using an e-taxi service such as Uber is that you can touch down in a new city and hail a ride without really knowing how the local cab system functions. But this only works if your usual ride-hailing service is a) available in your target market, and b) has enough drivers on standby to pick you up. Short one of these factors, travelers are back to square one.

But is there another way around this problem?

When Didi put \$100 million into Lyft back in 2015, it was more than a simple investment — it was a reciprocal agreement whereby Lyft and Didi customers could access each other's services while traveling. Lyft later inked a similar deal with Grab in Southeast Asia.

In many ways, this is like bringing the airline alliance model — including codeshare agreements through which multiple airlines share a specific flight's route from A to B — to the ride-hailing industry. Except both these roaming deals are now dead in the water, which suggests there just wasn't enough demand for such "cross-border coordination," given that Lyft and Didi only operate in two markets, while Grab is only available in six markets.

Didi hasn't given much of a clue as to what such "flexible" partnerships would

involve, but the Careem investment represents part of a broader tie-up that will see the duo "share knowledge in intelligent transportation technology, product development, and operations," according to a statement.

"Growing urban populations and economic and social diversity in the MENA (Middle East and North Africa) region present enormous opportunities for the ride-hailing economy," said Cheng Wei, founder and CEO of Didi Chuxing. "Careem is the region's technology and market leader. Through technology exchange and co-development, we look to support continued growth and transformation of the region's transportation industry, tap into the significant potential of the local internet economy, and foster more innovative services for a broader network of communities around the world."

Though Didi's attempt at a reciprocal "user-sharing" model with Lyft didn't work out, Uber is available globally in dozens of markets, and such a collaboration would perhaps make more sense in Uber's case.

As it happens, when Uber jumped into bed with Yandex in Eastern Europe, it opened the doors to both companies in markets where they would otherwise struggle. As the two platforms are connected, the rider apps will be kept separate but the driver apps will be fully integrated, allowing them to pool each other's drivers. This means that Yandex riders will gain instant access to Uber drivers not only in the six aforementioned markets, but also when trav-

elling abroad — so a Moscow-based businessperson traveling to New York or London can tap Uber's drivers from within the Yandex app.

This will work the other way around, too, meaning an Uber user from Melbourne, Lisbon, or Copenhagen can access Yandex drivers if they visit Russia or Belarus, for example.

"This creates one of the most convenient ride-sharing roaming agreements in the world," noted Yandex.taxi CEO Tigran Khudaverdyan at the time of the announcement.

Tourism

Both Uber and Didi have also made moves to expand their appeal among travelers by focusing on language accessibility. Back in 2015, Uber announced a partnership with language-learning platform Duolingo to help match English-speaking riders with English-speaking drivers, giving riders an option within the Uber app that would limit their driver pool to those proficient in the English tongue. Uber also offers an UberEspañol service in some U.S. cities for those seeking a Spanish-speaking driver, but this bypasses Duolingo's language-vetting services.

Tourism, it seems, is central to both Uber and Didi's philosophies on globalization.

The state of play

As the global e-taxi industry continues to evolve, what we're seeing is the formation of alliances, some more rigid than others. There are full-on acquisitions, with Didi buying out Uber in China, and MyTaxi chipping away at various smaller local firms. But we're also seeing new joint ventures between existing services, such as when Uber and Yandex joined forces.

While it's not yet clear how all of this will play out in the long term, what is clear is that Didi is chasing Uber by investing in its rivals. Uber raised a lot of money early on and tried to aggressively grow its brand in countless markets around the world. But Didi has been playing catch up and is now funding Uber's competition as it keeps its eye on rewards further down the line.

(Source: Venturebeat)

Hacking a computer using DNA is now a reality

By Samuel Gibbs

Researchers from the University of Washington say they have successfully hacked into a computer using custom strands of DNA for the first time.

Akin to something from the pages of science fiction, the researchers used the life-encoding molecule to attack and take over a computer, using strands of DNA to transmit a computer virus from the biological to the digital realm.

"We designed and created a synthetic DNA strand that contained malicious computer code encoded in the bases of the DNA strand," wrote the researchers led by Tadayoshi Kohno and Luis Ceze from the Paul G Allen school of computer science and engineering at the University of Washington.

"When this physical strand was sequenced and processed by the vulnerable program it gave remote control of the computer doing the processing. That is, we were able to remotely exploit and gain full control over a computer using adversarial synthetic DNA."

The researchers used the four bases in DNA, adenine, cytosine, guanine and thymine — A, C, G and T — to encode their malware, which when read by a piece of DNA sequencing equipment converted the molecular code



into computer code capable of taking over the computer connected to the DNA sequencer.

The hack was only possible because of weakness in the DNA sequencing software, and only in this specific instance. The researchers say that there is no reason for concern: "Note that there is not present cause for alarm about present-day threats. We have no evidence to believe that the security of DNA sequencing or DNA data in general is currently under attack."

Instead the researchers are using their results to illustrate the need for better security within the DNA sequencing systems in use today. The idea for the research came from an analysis of the commonly used open-source

sequencing software, which processes and analyses the results from sequencing machines, found cybersecurity weaknesses and a failure to follow security best practices meaning that they could be vulnerable to attack.

The results show that it is technically possible to use DNA as a way to transfer malware and attack vulnerabilities in the sequencing compute program.

"It is time to improve the state of DNA security," say the researchers. "We again stress that there is no cause for people to be alarmed today, but we also encourage the DNA sequencing community to proactively address computer security risks before any adversaries manifest."

Research has already shown that it is possible to transfer data using DNA. In April 2016, Microsoft and the University of Washington demonstrated a technique for storing and retrieving digital images using DNA. That research aims to turn DNA into a viable storage medium for digital information, using its unique properties to store vast amounts of information in tiny amounts of liquid.

In July this year, scientists from Harvard managed to store moving pictures in the DNA of a living cell as part of researched aimed at creating a molecular data recorder that could sit inside living cells.

(Source: Guardian)

Only 11% of consumers willing to pay \$1,000 for a new iPhone



New information sent by Barclay's to its clients, and obtained by CNBC, reveals that the price of the Apple iPhone this year might finally reach a point that turns consumers away.

The tenth anniversary model is dubbed the Apple iPhone 8, and early speculation has put a price tag as high as \$1,000-\$1,200 on the handset. But the bank's survey shows that only 11% of those who responded to it said that they would pay more than \$1,000 cash for an iPhone. Among existing iPhone owners, that 11% rises to 18%. (Source: CNBC)

Microsoft patent application shows metallic Surface Phone body

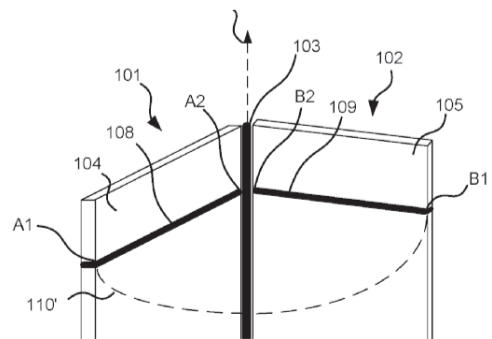

Since the beginning of the year, we have seen a few Microsoft patent applications that were said to feature the mythical Surface Phone.

The latest such patent application was published on Thursday, even though it had been filed with the USPTO back in February 2016.

The patent, entitled "Cover of Device Acting as Antenna of the Device" shows a metallic built handset. As the title of the patent suggests, the metallic cover doubles as the antenna. (Source: MSPoweruser)

Samsung Galaxy Note 8 with Snapdragon 835 SoC gets benchmarked



The first benchmark that shows the performance results of the upcoming Samsung Galaxy Note 8 appeared online. Samsung SM-950F is the Exynos-based version of Galaxy Note 8, one that will be sold as the international model.

However, customers in the United States will get a slightly different Galaxy Note 8 model, which will be equipped with a Qualcomm Snapdragon 835 processor instead of the Exynos 8895 that was benchmarked recently. (Source: Geekbench)

Stars orbiting Supermassive Black Hole show Einstein was right again

At the center of our galaxy, roughly 26,000 light years from Earth, lies the Supermassive Black Hole (SMBH) known as Sagittarius A*. Measuring 44 million km across, this object is roughly 4 million times as massive as our Sun and exerts a tremendous gravitational pull. Since astronomers cannot detect black holes directly, its existence has been determined largely from the effect it has on the small group of stars orbiting it.

In this respect, scientists have found that observing Sagittarius A* is an effective way of testing the physics of gravity. For instance, in the course of observing these stars, a team of German and Czech astronomers noted subtle effects caused by the black hole's gravity.

In so doing, they were able to yet again confirm some of the predictions made by Einstein's famous Theory of General Relativity.

Supermassive Black Hole

Their study, titled "Investigating the Relativistic Motion of the Stars Near the Supermassive Black Hole in the Galactic Center", was recently published in the *Astrophysical Journal*.

As is indicated in the course of it, the team applied new analysis techniques to existing observations that were made by European Southern Observatory's (ESO)

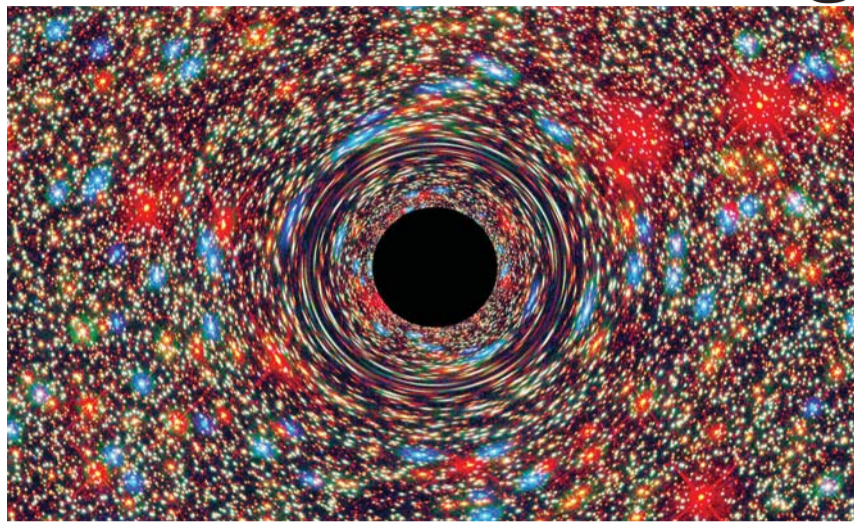

Very Large Telescope (VLT) and other telescopes over the course of the past 20 years.

From this, they measured the orbits of the stars that orbit Sagittarius A* to test predictions made by classical Newtonian physics (i.e. Universal Gravitation), as well

as predictions based on general relativity. What they found was that one of the stars (S2) showed deviations in its orbit which were defied the former, but were consistent with the latter.

This star, which has 15 times the mass of our Sun, follows an elliptical orbit

Essentially, the research team noted that S2 had the most elliptical orbit of any star orbiting the Supermassive Black Hole.

around the SMBH, completing a single orbit in about 15.6 years.

Sun and the Earth

At its closest, it gets to within 17 light hours of the black hole, which is the equivalent of 120 times the distance between the Sun and the Earth (120 AU).

Essentially, the research team noted that S2 had the most elliptical orbit of any star orbiting the Supermassive Black Hole.

They also noted a slight change in its orbit – a few percent in the shape and about one-sixth of a degree in orientation. This could only be explained as being due to the relativistic effects caused by Sagittarius A* intense gravity, which cause a precession in its orbit. What this means is, the elliptical loop of S2's orbit rotates around the SMBH over time, with its perihelion point aimed in different directions.

Interestingly enough, this is similar to the effect that was observed in Mercury's orbit – aka. The "perihelion precession of Mercury" – during the late 19th century. This observation challenged classical Newtonian mechanics and led scientists to conclude that Newton's theory of gravity was incomplete. It is also what prompted Einstein to develop his theory of General Relativity, which offered a satisfactory explanation for the issue.

(Source: Universe Today)

Glow like kryptonite with the solar charged jacket from Vollebak

No one likes being left without a light source. With this Solar Charged Jacket, the light is never far.

Whether out for evening jog or a hike under moonlight, visibility is important. Vollebak's latest, the Solar Charged Jacket, ensures that outdoor enthusiasts are never without light. Like something out of the comics, the jacket stores light energy to maintain a glow for up to 12 hours.

Just like glow-in-the-dark toys from peoples' childhood, the Solar Charged Jacket fuels itself in sunlight. The easiest way to charge it up for the night is by wearing it outside during the day.

Whether it is two minutes or two hours, the jacket will store the light energy and glow as soon as it gets dark.

Longer time in the light will be reflected in a longer glow, and just a couple hours in the sun will grant users up to 12 hours of soft, green light. Even on a cloudy day, the sun's light is bright enough to charge it up.

Glowing effect

If the jacket spent all day in the closet or in a bag, the glowing effect can be achieved in as little as two seconds with a smartphone's flashlight. If users want to be visible during a nightly run or bike ride, they can also charge it using car headlights or a standard 60-watt bulb.

In broad daylight, the glow won't be visible. Instead, jacket owners can enjoy a more subtle light gray. The core glowing ability of the jacket comes from an ultra-thin layer inside of a translucent mesh.

For those worried about washing off the magic, the phosphorescence is engineered into the membrane itself, inside of the fabric. No amount of washing or rubbing will remove its glowing property.

Outside of its luminescence, the Solar Charged Jacket is also a high-performance rain jacket. The waterproof membrane keeps the user dry during the heaviest of downpours while remaining soft and breathable to prevent excess sweating.



The thin fabric also makes it compact enough to roll up into one hand. Unlike many other shells, this jacket maintains a large amount of elasticity, making it perfect for movement.

(Source: Digital Trends)

Marine noise pollution stresses and confuses fish

Researchers at Newcastle University (UK) found that European sea bass experienced higher stress levels when exposed to the types of piling and drilling sounds made during the construction of offshore structures.

The fish also showed signs of being confused when they encountered a potential predator while exposed to these underwater noises.

When researchers played recordings of piling sounds and mimicked an approaching predator, the seabass made more turns

and failed to move away from the predator.

When exposed to drilling sounds the sea bass actively avoided these areas, spending more time in what the research team called the 'safe zone'.

The fish also took longer to recover from exposure to the underwater sounds. Lead researcher Ilaria Spiga explained: "Over the last

few decades, the sea has become a very noisy place.

The effects we saw were subtle chang-

es, which may well have the potential to disrupt the seabass's ability to remain 'in tune' with its environment.

Response mechanism

"Sea bass, along with other bony fishes, rely on a characteristic 'startle and response' mechanism to get away from predators.

Exposure to underwater noises can make it harder for fishes to detect and react to predators. It could also impair their own ability to detect food.

"Man-made marine noise could poten-

tially have an adverse effect on reproduction also. If fishes actively avoid areas where these sounds are present it could prevent them from entering spawning grounds, or affect communication between individuals."

The researchers played recordings of drilling from the English Channel made during the installation of a new tidal barrage, while the sound of piling was taken from the construction of a new lifeboat station at Swansea Bay.

(Source: EurekAlert)

Valuable Agricultural Commodities' Fund to Be Launched

Mercantile Exchange especially Agricultural Mercantile Exchange is considered as one of the oldest markets in Iran and even the world, Public Relations Dept. of Iran Mercantile Exchange (IME) reported.

As Mercantile Exchange can be considered as the venue for supplying staples in the country, long-term horizon should be considered for this market, the issue of which is pa paramount importance.

Of the other issue that should be taken into consideration in this market, it should be referred to "financing" which is of paramount importance.

Agricultural sector, due to specialty of type of available goods in its and its demanding volume, is considerable both for consumer and producer.

Time-consuming issue of production method in agricultural sector and lack of liquidity especially in the working capital sector have caused significance of changing methods of financing in this sector.

With due observance to the said issue, monetary



and banking sectors of the country cannot afford this sector due to the certain terms and conditions.

Given the above issue, it can pin hope that financing specially working capital through financial markets especially mercantile exchange will be signified to a great extent.

To learn more about the details, our correspondent

has conducted an interview with Dr. Hamed Soltaninejad, Chief Executive of Iran Mercantile Exchange which comes as follows:

Let's review the interview in questions and answers:

Q: The latest event happened in Iran Mercantile Exchange (IME), which could affect the agricultural sector, was supply of day-old chick. Why was day-old chick selected for supply at this market? Has supply of day-old chick been ever occurred in the world or even Iran Mercantile Exchange (IME)?

A: In response to your question, I should say that day-old chick is considered as one of the main sources of chicken breeding. The structure which exists in the production of day-old chicken, is the structure of various and sporadic suppliers in different parts of the country without informing on the way of function, performance and production of other activities in this sector.

Over 90b Rials Paid to Families of Victims of Azadshahr Mine Incident: AIC

Asia Insurance Company (AIC) paid 90,300,000,000 rials indemnity to the families of victims of Azadshahr's Zemestanyurt Mine tragedy, Public Relations Dept. of the company reported.

For his part, Hamid-Reza Sa-

ri-Aslan Asia Insurance Company's Liability Insurance Manager said: "Asia Insurance Company paid totally 90,300,000,000 rials compensation to a number of 43 mine workers who lost their lives in Azadshahr's Zemestanyurt Mine incident according

to observing social responsibility of economic enterprises and honoring clientele."

He put the compensation for each mine worker who died of mine blast in this region at 2,100,000,000 rials.

Elsewhere in his remarks, the direc-

tor pointed to the payment of compensation in four stages and said: "In the fourth phase of compensation, a number of seven families of victims of mine incident in this area attended branch office of Asia Insurance Company in Gonbad-e Kavous."

Sustainable Credit Perspective to Be Foreseen for EDBI Financial Assistance

In its latest report released in July 2017, International Capital Intelligence Institute put the financial rating of Export Development Bank of Iran (EDBI) at "-BB", the Public Relations Dept. of the bank reported.

In addition, the credit rating institute announced long- and short-term foreign currency rating of the bank at "-BB" and "B" respectively.

Since capital adequacy of the bank has significantly been

reduced in the last two years, the capital adequacy of the bank currently stands at appropriate level, the issue of which is one of the strengthening factor of the bank rank.

It should be noted that financial capability rank of the bank is still affected by the relatively difficult operational environment, high risk of the country and also low share of available cash assets.

According to CI's prediction, profitability will still re-

main weak due to the severe requirements of reserving although it is expected that operating profit will stand at appropriate level due to the low cost price.

As commissioner of policies of the government, Export Development Bank of Iran is a fully state-owned bank, aimed at promoting exports and export activities.

Profitability is the second priority of management of the bank, he said.

Early humans may have lived through a supervolcano eruption

The eruption of a supervolcano is extremely powerful, but also a very rare event. The previous one happened 25 million years ago, long before humans ever evolved. However, the last happened just 71,000 years ago, when Toba, located on the island of Sumatra, blow up. The caldera of Toba, a hole visible even from space, formed when the volcano collapsed during the eruption. Estimated 1,700 cubic-miles of rock, a volume comparable to almost 3 million Empire State Buildings, were displaced by the eruption.



Toba was at least one to two magnitudes larger (and 10 times more powerful) than Tambora, considered the most violent eruption witnessed by humans in modern history.

The eruption of Tambora in 1815 was followed by years of unusual chaotic weather in Europe, Asia, and America, as the volcanic ash disrupted Earth's atmospheric circulation. Toba send even more ash into the atmosphere. Some authors have suggested that the Toba supervolcano eruption and resulting volcanic winter almost killed off our species.

Genetic evidence suggests, that around 70,000 years ago the human population, widely distributed on the African continent, suddenly collapsed.

Only a small group survived. The exact cause of this genetic bottleneck is unknown, but a volcanic winter, with widespread and severe droughts in Africa, could maybe explain the reduced genetic variability.

Most early humans didn't make it, as the climate and environment suddenly changed everywhere, and only a small group, with limited genetic variability, survived by chance in Eastern Africa. Later this group left Africa, migrating north into Europe and east into Asia. We, as modern humans, descend from those survivors.

(Source: Forbes)

Intelligent life in the universe might already be extinct

Intelligent life goes extinct shortly after becoming technologically advanced and that's why we haven't been able to connect with any alien species, one scientist is arguing.

At the center of his assertion is the mediocrity principle, which is popular among astronomers and dictates that there is nothing special about our species, our planet or our solar system — that everything that went into the evolution of human life on Earth could have happened in other places as well. It thus also dictates that the state in which we find ourselves is completely typical and can be generally applied to the rest of the universe.

University of Arkansas professor Daniel Whitmire is suggesting that if we go by this principle, it stands to reason that any technological species would find themselves in a similar situation to humans on Earth: "that they are both the first such species to evolve on their planet and also that they are early in their potential technological evolution," according to his paper in the *International Journal of Astrobiology*. He argues that this implies intelligent species do not exist further along in technological evolution because they have gone "extinct soon after attaining a modern technology and that this event results in the extinction of the planet's global biosphere."

(Source: IBT)

NASA to wake up New Horizons spacecraft for voyage into mysterious Third Zone

NASA is to wake up its New Horizons spacecraft next month following a five-month hibernation, ahead of a journey deeper into one of the most mysterious regions of the Solar System.

New Horizons, which captured incredible images of Pluto in July 2015, was powered down in April to conserve energy as it travelled through the Kuiper Belt, a vast region of icy debris which encircles the Sun and planets, also known as The Third Zone.

On September 11, the spacecraft will awaken for its 16 month journey to MU69, an ancient object which is thought to be one of the early building blocks of the Solar System.

The space rock had not even been discovered when the craft launched in 2006 and the flyby will be the most distant in the history of space exploration, a billion miles beyond Pluto, and four billion miles from Earth.

Recent observations of MU69 from the Hubble Space Telescope show it is probably two 'binary' objects or a pair of space rocks 'stuck-together' bodies which are each around 12 miles across.

Alan Stern, Principal Investigator for New Horizons at NASA, said: "We are very likely going to a primordial binary in the Kuiper Belt, a four-billion-year-old relic of Solar System formation and an exotic building block of the small planets of the Kuiper Belt like Pluto.

(Source: The Telegraph)

Kalantari appointed new environment chief

ENVIRONMENT TEHRAN — President Hassan Rouhani in a decree on Sunday appointed Isa Kalantari as the vice president and the new chief of the Department of Environment.

Kalantari, 65, served as agriculture minister during the Akbar Hashemi Rafsanjani presidency from 1989-97 and the first year of President Mohammad Khatami's administration from 1997-98.

He replaced Masoumeh Ebtekar who has been appointed as the vice president for women and family affairs in Rouhani's new administration.

Kalantari holds a BSc in agriculture from Urmia University, an MSc in physiology-biochemistry from Iowa State University, and a PhD in agricultural physiology from University of Nebraska.

He has also served as the advisor to president Rouhani in water, agriculture and environmental affairs. In February 2014, he was appointed as the chairman of a committee tasked with restoration of Lake Urmia.

Kalantari has openly voiced serious concerns about water scarcity in Iran. He has warned if the current extravagant use of water is not revised millions of people in the country will be forced to migrate.

100-year-old cake found near South Pole

A 100-year-old fruit cake has been found in the oldest building in Antarctica and those who discovered it think it looks fresh.

The cake is believed to date to Robert Falcon Scott's Terra Nova Expedition between 1910 and 1913.

Although the tin containing the cake was rusted and falling apart, the cake inside "looked and smelt (almost edible)" according to the Antarctic Heritage Trust.

Lizzie Meek, the program manager for artefacts at the Trust, said: "With just two weeks to go on the conservation of the Cape Adare artefacts, finding such a perfectly preserved fruitcake in amongst the last handful of unidentified and severely corroded tins was quite a surprise.

"It's an ideal high-energy food for Antarctic conditions, and is still a favorite item on modern trips to the Ice."

The cake and its tin have been taken to New Zealand's Canterbury Museum laboratory, where the Trust's staff are working on conserving almost 1,500 artefacts.

Scott's expedition had a number of objectives, but reaching the pole was key - and although they ultimately succeeded they found that the Norwegians had beaten them to it.

Tragically the entire party died on the return journey from the pole.

(Source: msn.com)

LEARN ENGLISH

Applying for a Visa

A: So, you're applying for a **B2 visa**, where is your final destination and what's the purpose of your trip to the United States?

B: I'm going to visit my brother; he's just had a baby. He lives in Minneapolis.

A: And how long do you plan to **remain** in the United States?

B: I'll be here for **approximately** three weeks. See, here's my return ticket for the twenty-sixth of March.

A: And, who is **sponsoring** your trip?

B: My brother, here, this is an **invitation letter** from him. I will stay with him and his family in their home.

A: Alright, tell me about the **ties** you have to your home country.

B: Well, I own a house; actually, I'm leaving my dog there with my neighbors. I have a car at home, and oh, my job! I'm employed by Tornel as an engineer. Actually, I only have three weeks' vacation, so I have to go back to work at the end of March.

A: And what **evidence** do you have that you are **financially independent**?

B: Well, I do have **assets** in my country; like I said, I own a house, and see, here's a bank statement showing my investments, and my bank balance.

A: I'm sorry, sir, we cannot **grant** you a B2 visa at this time, instead, you are granted a resident visa! Congratulations, you are the millionth person to apply for a visa! You win! Congratulations!

Key vocabulary

B2 visa: B-2 visa id for pleasure or medical treatment' B1 and B2 are non-immigrant visas and are normally issued up to a period of 3 months to 10 years

remain: stay

approximately: an amount that is almost, but not exact

sponsor: someone who takes the responsibility for a person applying for a visa

invitation letter: a formal letter asking a person to come to a place

tie: responsibility that links a person to a place or a thing

evidence: something that shows the thing is true

financially independent: have enough money to live alone; do not need help with money

assets: things that are worth money that you own

grant: let you have something

Supplementary vocabulary

visa officer: a person who's job is to interview people for visas

resident permit: an official document that allows you to live in a country

embassy: the group of people who represent your country in another country, located in the capital city

application form: a piece of paper you have to put information on to make a formal request

consulate: government building representing your country in another country; not located in a capital city

(Source: irlanguage.com)

Endangered Hircanian forests saved against mining exploration

ENVIRONMENT TEHRAN — The governor general of the northern province of Mazandaran has rescinded a permit for mining exploration across 11,000 hectares of Hircanian forests in a move toward saving valuable, yet endangered natural resources.

Mohammad Darvish, an official with Department of Environment (DOE), said on Saturday that Mazandaran Governor General Rabi Fallah Jelodar has revoked a mining exploration permit he had issued earlier this year to protect the ecologically sensitive forests from deforestation.

According to the DOE official website the mineral extraction in the heart of the valuable and old-growth Hircanian forests have aroused determined opposition of Department of Environment, Forests, Range and Watershed Management Organization, and environmental NGOs for some weeks now.

"The mining exploration permit even prompted the resignation of Hosseinali Ebrahimi, Mazandaran province head of department of environment, in an effort to safeguard the forests and preventing an environmental catastrophe," Darvish highlighted.

Farhad Dabiri, the deputy director of Iran's Department of Environment, also stated that the DOE has previously strived to revise the laws on issuing mining exploration permits which was rejected by the Industry, Mining and Trade Ministry.

However, a working group compris-



ing experts both from DOE and Industry, Mining and Trade Ministry formed to protect ecologically sensitive areas from environmentally disruptive activities such as mining, Dabiri said, adding, but this time, regardless of the previous agreements a permit was granted for mining exploration in Hircanian forests.

Ebrahimi, Mazandaran province head of department of environment, also noted that the aforementioned mining exploration project was supposed to be set up in separate 7 sites stretching over a land area of 11,200 hectares.

More than two third of the targeted

area is covered in forests and the rest were rangelands, Ebrahimi said. "In fact implementing the project could have posed a threat to some 200,000 hectares of Alborz protected area."

The Caspian Hircanian Mixed Forests ecoregion is covering about 55,000 square kilometers near the southern shores of the Caspian Sea of Iran and Azerbaijan.

The forest covers parts of five provinces of Iran from east to west including: North Khorasan Province, Golestan Province, Mazandaran Province, Gilan Province and Ardabil Province.

Hircanian forest granted the areas with unique richness of biological diversity, its endemic and endangered species, its natural beauty and its masterpieces of nature creative genius in the form of this ancient forest.

The forest contain the most important and significant natural habitats for in-situ conservation of biological diversity, including those containing threatened species of outstanding universal value from the point of view of science or conservation. It also contains superlative natural phenomena or areas of exceptional natural beauty and aesthetic importance.

Mining has always been an environmentally disruptive activity, but contemporary extractive industries are located in some of the most ecologically sensitive forests.

Oil, coal, gas, and minerals extraction reduce forest cover, but also lead to more long term impacts such as pollution, infrastructure development and increased human activity. Extractive industries produce toxic water and chemicals as byproducts that can contaminate groundwater and kill flora and fauna. Weak regulation in policy and practice has hindered effective monitoring and accountability processes in developing countries.

With the growth of fossil fuels and minerals extraction in developing countries, the threat of pollution from oil spills and mining waste will continue to rise.

The favorite word of average people: "Okay"

By Brian Lee

I remember learning the word, "okay," as a child and marveling at its versatility. It has such a broad meaning that you can use it in many contexts, and as a kid working to communicate with a limited vocabulary, being able to say "okay" carried me through all sorts of scenarios.

As I've gotten older, my feelings about the word have changed. When saying "okay" used to give me freedom, now it holds me back. I've learned that in most cases, it's not okay to say, "OK."

Okay has become a toxic cop out

Sure, you can say "ok" in almost any situation. For example: "How was the article?" "It's okay." "How was that candidate?" "She was okay." "How's your life?" "It's okay."

Saying that something is okay doesn't tell us much about it. Usually it means that something is satisfactory, but it's not especially good. It's a way to avoid conflict by failing to give meaningful feedback. It allows us to avoid committing to authentic communication.

When we say something is okay, we stop thinking

Not only does referring to something as okay keep us from providing a valuable assessment of the thing in question, but it keeps us from thinking about how to make that thing better.

Instead of trouble shooting and finding solutions, we check the "okay" box and move on to more interesting pursuits. When someone comes to us looking for feedback, telling them that something is okay doesn't give them any idea about how to improve.

Labelling everything as "okay" makes you boring

Something that is just okay needs more work. People who label things in this manner are providing a lazy answer. Okay is a boring answer to a host of interesting questions, and it's up to you to do better.

Communication is a two-way street. A person who asks for your honest opinion about a subject doesn't want to hear that something is okay. You might as well say your opinion on all things is, "meh," because you're just that uninspiring.

"Okay" connotes a lack of ideas or an unwillingness to contribute something more substantial to the conversation. If everything is just okay all the time, the people who talk to you will grow bored. They'd get more feedback talking to the wall. You've made it their sole responsibility to keep the conversation afloat, which can be tiresome.

Saying "okay" too often makes people feel that you're too agreeable

You can be easy to work with and disagree with people sometimes. When an idea is taking shape, you want all kinds of feedback and some push-back so that you can create something excellent. A collaborator who says that something is okay is simply saying that they don't have a strong opposition to the idea. They may not love it, but it's not worthwhile enough to improve.

You may think that you're being nice when you label things as okay, but you're not doing anyone any favors. "Okay" can be downright dishonest if you don't like an idea that much, but at the very least, it is not helpful. A person who comes to you with an idea would love new insights or constructive feedback. It already takes so much to ask for feedback. Don't deprive someone who values your opinion of the perspective that you could offer.

Maybe you are nervous that you'll offend someone. Giving actual feedback may feel risky, but when someone asks for it, honesty is the best policy. When you make a non-committal remark like, "It's okay," you've revealed your overly cautious mindset.

Give concrete feedback instead when you want to say "okay"

"Okay" isn't helping your communication skills. Erase it from your vocabulary, and work on offering your true

opinion. It may take some practice to feel good about this new way of expressing yourself, but your friends and colleagues will appreciate your honesty.

You can say something is OK if you offer more details

Good communication requires that you include specific details when you offer your opinion. If you do end up saying that something is okay, be sure to add on to the response. It doesn't have to be some great insight, but mentioning something can start a conversation that allows you and the other person to form a deeper connection.

"How did you like my short story?"

"It was ok. I liked the overall concept, but there were a few things I didn't understand."

An exchange like this could open up a conversation about how to improve the author's work. In this case, the author trusted that the other person would give honest feedback. The conversation could continue with, "What would it take to make this outstanding? What could be done to make it better?" These additional details show the person that you are basing your opinion on your best judgment rather than issuing a default response.

Don't accept "okay" from yourself either

If saying "okay" isn't a good enough response to someone else's question, it shouldn't be the go-to answer you give to

yourself either. Saying that you or something in your life is okay means that you feel adequate about it, but it doesn't demonstrate any motivation or potential for a major breakthrough.

People are more likely to tell themselves that they're doing okay when they're facing big challenges or pursuing difficult goals. Sometimes this defense mechanism can make you feel better about the situation when things are overwhelming, but saying that a situation is okay doesn't allow you to make changes or push through the task. "It's okay," quickly turns into, "I'll worry about it tomorrow." It's a real drain on motivation.

Remember that successful people don't go through their lives okaying every challenge that comes their way. They tackle these things head-on and become stronger in the process. They doggedly pursue their dreams until they achieve them.

Say "okay" when you don't care

"Okay" is a fine response when you don't care about something. Use it when you are trying to save time, or when you don't want to engage in discussion.

But for things that you do care, remember it's okay to say something besides "OK". You are capable of giving useful feedback and having opinions. It's our ability to grow when we work together that leads to innovation. Don't hide your greatness behind an answer as simplistic as "okay."

(Source: Lifehack)

Second Announcement

N.I.O.C
1396.2056

National Iranian Drilling Company

Public Calls For Quality Evaluating Of Tender(First Publish/Seconed Publish)

One-Stage(compressed)						
TENDER GUARANTEE		ESTIMATED VALUE (Rial)	Subject of Tender	Tenders Portal Reg. No.	TENDER NO. / INDENT NO	No
Euro	Rial					
14, 000	490, 000,000	9,795,743,400	P/F "GOLTECH" MEASURING WHILE DRILLING-MODEL:ZT-MWD	1/494/339	Tender No.:FP/12-96/025 Indent No.: 08-22-9645031	1

Brief discription of subject:
National Iranian Drilling Company(NIDC) address pasdaran Blev., Airport Saqare, Ahwaz, Iran hereby intends to purchase its requirements from qualified and interested tenderers through one-stage public tender (compressed) upon following terms and conditions:

A) Qualitative evaluation of tenderer:
The evaluation is based on article (J) implementing regulations of the law of tenders and also carried out base on worksheets qualitative evaluation inquiry in the tender documents. Minimum acceptable point of quality is 60.

B) Preparation of tender documents:
Purchasing of documents:
In order to receive the tender documents, 510,000 Rials should be paid to SIBA account number 2174652205004 of NIDC in Bank Meli Iran and providing the original deposit receipt.
Notice: According to N.I.D.C technical and commercial committee rule, the limitation for job referrals in procurement field is four active and in process contract.
Receiving of documents:
Tenderers must be obtain the quality evaluation documents along with tender documents maximum ten days after the date of second publication in person at the following address: Hall No.:113, 1thfloor, Foreign Procurement Dept., National Iranian Drilling Company, Airport square, Ahwaz, IRAN
Notice: Only the real or legal persons who apply to purchase and recieve tender ducments from foreign procurement department in due date and participates in tenderwill be known as tenderer from tender committee.

C) Delivery of envelopes of bids and call quality evaluating:
Tenderers shall submit simultaneously envelopes of bids including bank guarantees(A), financial offer(C) and stamped and signed of tender documents(B) along with qualification worksheets in form of software in CD and documentary within 40 days from last day of document received deadline to the following address: Hall No.:107, 1thfloor ,Tender Committee, Building operations, National Iranian Drilling Company, Airport square, Ahwaz, IRAN.
Notice: The deadline for the refusal of bidders participation in the the tender is the last day of determined for submission of bids.

D) Tender Guarantee:
Type of guarantee:
A)Bank guarantees or guarantees issued by non-bank institutions that have activites licensed by the Central Bank of the Islamic Republic of Iran.
B) The original cash deposit receipt paid to National Iranain Drilling Company.
Duration of credit guarantee & quotation:
This duration should be valid for 90 days and extendable maximum For one time in initial credit amount.
More on this & other tenders is accessible by click on. WWW.NIDC.IR
Foreign Procurement Dept
National Iranian Drilling Company

تهران تایمز : نوبت اول ۹۶/۵/۲۲ نوبت دوم ۹۶/۵/۲۳

Iraqi Kurds stick to independence vote despite U.S. request to postpone it

Iraqi Kurds are sticking to a plan to hold an independence referendum on Sept. 25, despite a United States request to postpone it, a high-ranking Kurdish official told Reuters.

The United States and other Western nations are worried that the vote could ignite a fresh conflict with Baghdad and turn into another regional flashpoint. Turkey, Iran and Syria, which together with Iraq have sizeable Kurdish populations, all oppose an independent Kurdistan.

"The date is standing, Sept. 25, no change," said Hoshiyar Zebari, a close adviser to Kurdistan Regional Government President Massoud Barzani, after the U.S. Secretary of State Rex Tillerson asked Barzani to postpone the referendum.

Tillerson made the request in a phone call with Barzani on Thursday, Zebari said.

"On the issue of the postponement of the referendum, the President (Barzani) stated that the people of the Kurdistan Region would expect guarantees and alternatives for their future," said a statement issued on Friday by the Kurdistan Regional Government (KRG) presidency, after Tillerson's call.

The U.S. State Department said in June it was concerned that the referen-



dum will distract from "more urgent priorities" such as the defeat of the Islamic State in Iraq and the Levant (ISIL/Daesh) terrorist group.

ISIL's self-proclaimed "caliphate" effectively collapsed last month, when the U.S.-backed Iraqi forces completed the takeover of the militants' capital in Iraq, Mosul, after a nine-month campaign in which Kurdish Peshmerga fighters took

part.

The ISIL terrorists remain however in control of territory in western Iraq and eastern Syria. The United States has pledged to maintain its backing to allied forces in both countries until the militants' total defeat.

Barzani, whose father led struggles against Baghdad in the 1960s and 1970s, told Reuters in July the Kurds would take

responsibility for the expected 'yes' outcome of the referendum, and pursue its implementation through dialogue with Baghdad and regional powers to avoid conflict. "We have to rectify the history of mistreatment of our people and those who are saying that independence is not good, our question to them is, 'if it's not good for us, why is it good for you?'" he said in an interview in the KRG capital, Erbil.

The country's majority Shia community mainly lives in the south while the Kurds and Sunni Arabs inhabit two corners of the north. The center around Baghdad is mixed.

Kurdish officials have said disputed areas, including the oil-rich Kirkuk region, will be covered by the referendum, to determine whether they would want to remain or not in Kurdistan.

The Kurdish Peshmerga in 2014 prevented ISIL from capturing Kirkuk, in northern Iraq, after the Iraqi army fled in the face of the militants. They are effectively running the region, also claimed by Turkmen and Arabs.

Hardline militias have threatened to expel the Kurds by force from this region and three other disputed areas - Sinjar, Makhmour and Khanaqin.

(Source: Reuters)

Russia: Syrian government doubles territory it controls

Russian Defense Minister Sergei Shoigu says the Syrian government has increased the size of the territory under its control by 2 1/2 times in just two months.

Shoigu made the comments in an interview with state-owned TV channel Rossiya 24 on Sunday in which he predicted the end of the fight with the Islamic State in Iraq and the Levant (ISIL/Daesh) terrorist outfit.

Shoigu said the fall of the militant stronghold Deir el-Zour on the Euphrates "will say a lot, if not everything, about the end of the battle with" ISIL.

Russia is a close ally of the Syrian regime and has been providing air support for Syrian forces since 2015. Under pressure from Western-backed forces in Iraq and Syria, ISIL has seen the territory it holds contract in recent months.

■ Syrians return home in droves, mostly to Aleppo

Meantime, more than 600,000 Syrians have returned to their homes in the seven months from January, mostly to the northwestern province of Aleppo which the government liberated at the end of 2016.

According to the International Organization for Migration (IOM), it almost equaled the entire number of returnees in 2016.

About 67 percent, or more than 400,000, of the returns this year have been to Aleppo Province which the Syrian government liberated from foreign-backed terrorists in mid-December last year.

The liberation of Aleppo, Syria's second city and an ancient marvel, represented the most serious setback

for terrorists and their sponsors, tipping the scales in favor of the Syrian government.

Most of the 602,759 Syrians, who returned to their homes between January and July, had been uprooted within their homeland, while the other 16 percent returned from Turkey, Lebanon, Jordan, and Iraq, the IOM noted.

Syria, however, still contains more than six million internally-displaced people.

■ Syria to facilitate chemical probe

Separately, Deputy Syrian Foreign Minister Faisal Mekdad said an international chemical weapons delegation, comprising the United Nations chemical watchdog of the Organization for the Prohibition of Chemical Weapons (OPCW) and the world body's Joint Investigative Mechanism, is scheduled to arrive in Syria within 10 days.

He said Damascus would facilitate its mission to investigate a horrendous April 4 attack in Aleppo's neighboring province of Idlib.

Over 80 people died in the purported gas attack on the town of Khan Shaykhun in Idlib, which the Western countries blamed on the Syrian government.

Using the incident as a pretext, the United States warships fired 59 Tomahawk cruise missiles from two warships in the Mediterranean Sea at the Shayrat airfield in Syria's central province of Homs on April 7. U.S. officials claimed that the suspected Khan Shaykhun gas attack had been launched from the military site.



"We will offer it all facilitations needed for the investigation and to help it arrive to the place where the alleged chemical attack took place," Mekdad said. "We will ask them to go to Shayrat air base and by that Syria would have given proof that it has no relations to the use of poison gas," he added.

"We bet on the professionalism and neutrality of the Joint Investigation Mechanism that will visit Syria within the next ten days, to investigate who used chemical weapons," the Syrian official concluded.

The Syrian government turned over its entire chemical stockpile under a deal negotiated by Russia and the United States back in 2013. The OPCW oversaw the process.

(Source: agencies)

Deadly blast strikes Pakistan's Quetta

A blast in the Pakistani city of Quetta in Baluchistan province has killed at least 15 people and injured 32 others, reports say, in an incident blamed by the military on "terrorists".

Saturday's explosion targeted a military truck, killing eight soldiers and seven civilians who were nearby, the Pakistan's military said in a statement.

President Mamnoon Hussain condemned the attack, saying: "Our resolve won't succumb to any challenge".

The military said an incendiary explosive was used causing fire in vehicles parked near the area.

The blast occurred near a stadium where celebrations to mark the 70th anniversary of Pakistan's independence had been under way since Friday.

"We can now confirm that 15 people have died in the explosion today. At least 32 others are wounded," Sarfraz Bugti, Baluchistan home minister, told AFP news agency, adding that a rescue operation was under way.

A spokesman for the Baluchistan government, Anwar ul Haq Kakar, also confirmed the toll. Bugti said workers were busy extinguishing the blaze. He said the holidays of all doctors in the city were suspended.

"We are trying to transfer injured people to hospitals as soon as possible.

Workers are also busy extinguishing the fire at the site," he said.

The Islamic State in Iraq and the Levant (ISIL/Daesh) terrorist group claimed responsibility for the attack.

Quetta, the provincial capital of Baluchistan, has seen frequent attacks targeting government buildings and security forces, as well as civilians.

In June at least 12 people were killed and 14 others wounded in a suicide car attack near the provincial police headquarters.

■ Recent attacks

In February, two bomb-disposal squad members were killed and 11 others wounded in an explosion under

Quetta's Saryab bridge, according to local media reports.

In August last year, at least 74 people were killed in a suicide attack on the city's Civil Hospital, while another 60 were killed in an attack on a police academy two months later.

Past attacks in Baluchistan have been claimed by the Pakistani Taliban, ISIL, as well as by Baloch separatists who are fighting for independence from Pakistan.

Baluchistan has also seen a number of attacks carried out by the Lashkar-e-Jhangvi's Al Alami faction, a group with ties to ISIL, known for attacking Shia Muslims.

(Source: Al Jazeera)

Saudi prince seeks Iraqi mediation with Iran: Iraqi minister

Also, on Saturday Iranian media outlets reported the reopening of the Hajj Office of Ayatollah Khamenei, the leader of the Islamic Revolution, in Saudi Arabia.

Iran and Saudi Arabia have been locked in a list of disagreements, including the situation in Syria. Subsequent stumbling points have widened the rift.

The execution of a prominent Shiite cleric, Sheikh Nimr al-Nimr, by Riyadh in January 2016 prompted protesters in Tehran and Mashhad to ransack the Saudi diplomatic posts.

Following the attacks, Riyadh cut all diplomatic ties with Tehran, giving Iranian diplomats in Saudi Arabia 48 hours to leave the country with the impasse still smoldering.

The development kicked off a new round of sparring between the two regional rivals.

The unprecedented mutual vitriol has negated efforts so far to resolve a Hajj stampede in 2015, during which 464 Iranian pilgrims were killed. Iran cancelled participation in Hajj 2016, blaming Saudi mismanagement for the cancellation.

Iran and Saudi Arabia have also been trading barbs over the situation in Yemen, under the Saudi-led airstrikes since March 2015. Unlike Saudi accusations, Teh-



ran denies the Houthis are a proxy Iranian force, calling for an end to the invasion.

In May, a war of words erupted as Mohammed bin Salman, who is also Saudi defense minister, accused Iran of trying "to reach the focal point of Muslims (Mecca)," saying that he would protect his kingdom against what he called Iranian efforts to dominate the Muslim world.

In unusually blunt remarks, Salman also threatened that any struggle for influence ought to take place "inside Iran,

not in Saudi Arabia," and ruled out dialogue with Tehran.

Reacting to the comments, Zarif accused the Saudi side of "dangerously" seeking tension.

The Qatar row has presented itself to be a new entanglement. Downgrading diplomatic ties with Iran featured in a list of 13 demands put in by the Saudi-led group which announced on June 5 they were severing ties with Qatar.

The group accuses Qatar of supporting "extremism" and of being too close to Saudi Arabia's regional rival Iran.

Still there is hope for a détente. While regional and international intervention has failed so far to bring Tehran and Riyadh to the negotiation table, resumption of the Hajj pilgrimage this year is happy news.

Also, Tehran has shown openness to a thaw. In a recent interview with France 24, Kamal Kharrazi, the head of Iran's Strategic Council on Foreign Relations and a foreign policy adviser to the Supreme Leader, said Iran was open to "dialogue" with Saudi Arabia despite escalating tensions.

"We know they (Riyadh) have made many mistakes in Yemen, Bahrain, Iraq and Syria, but we are still for dialogue," Kharrazi said.

Hezbollah chief makes speech on Israel's defeat in 2006 Lebanon war

Secretary General of the Lebanese Hezbollah resistance movement, Sayyed Hassan Nasrallah, delivered a speech on the occasion of Israel's defeat in 2006 summer war against Lebanon, on Sunday.

Sayyed Hassan Nasrallah, delivered a speech on the anniversary of Israel's defeat in the 33-day military onslaught against Lebanon back in the summer of 2006.

The secretary General of the Lebanese Hezbollah resistance movement, praised resistance of the Lebanese nation in the 33-day Israeli onslaught against Lebanon.

During his speech, Nasrallah noted that the main reason behind victory of Hezbollah fighters was their patience, steadfastness, valor and faith.

Stressing the rise in Hezbollah's power since the war in 2006, Nasrallah noted that the resistance group was ready to face any more act of aggression, warning that in case of new Israeli aggression, it will face a 100-times harder response that its forces saw during the 2006 war.

(Source: Press TV)

Senior ISIL commanders killed in Afghanistan air strike: U.S. military

Several senior members of the Islamic State in Iraq and the Levant (ISIL/Daesh) terrorist group's central Asian affiliate were killed in a United States air strike in Afghanistan, officials said on Sunday.

The attack on Thursday killed Abdul Rahman, identified by the U.S. military as the Kunar provincial emir for ISIL-Khorasan, according to a statement from the command in Kabul.

"The death of Abdul Rahman deals yet another blow to the senior leadership of ISIL-K," said General John Nicholson, the senior U.S. commander in Afghanistan.

Three other senior ISIL-K terrorists were also among those killed in the strike in eastern Kunar province.

Nicholson has vowed to defeat the ISIL terrorists in Afghanistan this year.

The group's emir, Abu Sayed, was reported killed in a strike on his headquarters in Kunar in July, the third ISIL emir in Afghanistan to be killed since July 2016.

In April, Nicholson deployed a 21,600-pound (9,797 kg) "Massive Ordnance Air Blast" bomb against ISIL positions in neighboring Nangarhar province, one of the largest conventional weapons ever used by the United States in combat.

On Saturday, Afghan officials said as many as 16 civilians, including women and children, had been killed by a U.S. air strike in Nangarhar, but American officials said only militants were killed.

As part of an increased campaign against both ISIL and the Taliban, the U.S. Air Force has dropped nearly 2,000 weapons in the country as of the end of July, compared to fewer than 1,400 in all of last year.

Despite some battlefield successes by Afghan and American special operations troops, ISIL has continued deadly attacks around Afghanistan, fueling fears that the group is seeking to bring the group's Middle East conflict to Central Asia.

(Source: AFP)

West Africa security threatened by growing herdsmen militancy

Reports suggest that the Middle Belt experienced 18 incidents involving herdsmen and farming communities between 1997 and 2010. These rose exponentially from 2011 to 2015 to 371.

The rise of the militant herdsman has further complicated an internal security situation already endangered by the Boko Haram insurgency in the North East.

The military capability of the militant herdsmen has become increasingly sophisticated. They use modern weaponry as well as mercenary fighters.

■ Military-style operation

Some of the attacks now include military style operations, sometimes with the use of supply helicopters and machine guns mounted on vehicles.

The attacks often take a "scorched earth" approach that level entire communities, and sustain offensives that last for months.

In West and Central Africa, herdsmen violence has assumed a dreadful transnational dimension. For instance, hired attackers recruited from Mali and Central African Republic have often been fingered in Fulani herdsmen attacks in other parts of Nigeria. Bands of mercenary fighters have also been involved in similar incidents in parts of Cameroon, Ghana, Mali, and Niger.

And there appears to be synergy — even if only tactical — between the Fulani assailants and other organized transnational criminals, such as cattle rustlers and insurgents in the sub-region.

The emerging transnational dimension of herdsmen militancy points to the need for a multilateral approach to manage it. Regional platforms, such as the Lake Chad Basin Authority, the Economic Community of West African States, the Mano-River Union, should step up to the plate and take action in the interest of regional security.

The Conversation There is also a need to check the excesses of the herdsmen through strong regulations. Open itinerant grazing should be restricted and grazing routes and reserves established. The ranch system of animal husbandry should be promoted as a substitute to mobile pastoralism. This can be done over time through public private partnerships. In addition, all perpetrators of violence under the pretext of farmer-herder conflict should be brought to book and punished severely to deter impunity and wanton criminal behavior.

(Source: Newsweek)

No change to Alexis Sanchez situation says Arsene Wenger

Alexis Sanchez returned to Arsenal training on Friday as manager Arsene Wenger maintains his stance that the forward will not be sold.

The Chile international has been linked with a move away from the club this summer with less than a year remaining on his current deal at the Emirates Stadium and could walk away for free at the end of the upcoming season.



Wenger has insisted several times that Sanchez will not be sold, although links with Manchester City continue.

Sanchez missed Arsenal's scintillating start to the new Premier League season, an abdominal injury forcing him to sit out the 4-3 victory over Leicester.

The 28-year-old watched from the stands as Olivier Giroud's late header earned the Gunners three points.

Rumours persist that Sanchez will leave before the window closes, with Wenger suggesting he will also miss the trip to Stoke next weekend.

Asked if there was any update on Sanchez's situation, Wenger replied: "No."

"He practiced well today, this morning, had a good session for the first time because he had a little muscular strain. He is focused and happy in the dressing room because we won the game."

(Source: PA Sport)

Ousmane Dembele suspended until further notice by Borussia Dortmund

Ousmane Dembele has had his suspension extended by Borussia Dortmund until further notice as he continues to be unsettled by interest from Barcelona.

The 20-year-old Frenchman skipped training on Thursday and was swiftly suspended by the Bundesliga club for the weekend's DFB-Pokal first-round encounter with minnows Rielasingen-Arlen.

Dembele is under contract with Dortmund until 2021 and an initial offer from the Spanish giants has been rejected by Dortmund.

And Dortmund have now made the decision not to lift the suspension on Dembele, with Sporting director Michael Zorc telling Dortmund's website: "Our focus now is on a concentrated preparation of the team for the Bundesliga opening match against Wolfsburg in the coming weekend."

"Ousmane Dembele has the possibility to do individual training off the group."

Dembele joined Dortmund a little over 12 months ago from Rennes on a five-year contract and has attracted top European suitors after a breakout season at the Westfalenstadion.

He scored 10 times in 49 appearances in all competitions in the last campaign while he broke his duck for France with the winner in the 3-2 friendly triumph over England in June.

(Source: Eurosport)

Heartbreak for Usain Bolt as farewell ends in injury

Usain Bolt's farewell appearance at the world championships ended in painful and disastrous fashion as he pulled up injured on the final leg of the men's 4x100m relay Saturday.

Bolt took the baton for Jamaica in third place but within a few strides he had fallen to the ground, clutching his left leg, as host Britain secured a shock gold ahead of a United States team containing Justin Gatlin.

The 30-year-old Bolt, beaten into third in the individual 100m behind Gatlin and his US team compatriot Christian Coleman, was comforted by teammates after getting to his feet, his face etched in pain.

The capacity crowd in the London Stadium was still digesting the shock earlier defeat for home hero Mo Farah in the men's 5,000m final, before the drama of Bolt's last agonizing appearance.

He had been bidding for a 12th world championship gold to bring down the curtain on his glittering career, but instead limped out of the London Stadium arena.

Victory for the British quartet of CJ Ujah, Adam Gemili, who ran a storming second leg, Daniel Talbot and Nethaneel Mitchell-Blake was stunning compensation for Farah's earlier defeat.

They won in 37.47 seconds, with the US taking silver at 0.05sec and Japan with a



surprise bronze.

For his massive global following, the perfect script would have seen the Bolt of old running down Britain and the US for yet another gold, but it was not to be.

"He didn't tell us exactly what happened but from what I saw, it looked like a strain or a cramp of some sort," teammate Julian Forte told IAAF radio.

"He kept apologizing to us but we told him there was no need to apologize — injuries are part of the sport."

Jamaican team doctor Dr Kevin Jones told AFP that Bolt had suffered from "cramp in his left hamstring".

"The last three weeks have been hard for him, you know. We hope for the best for him," he added.

Jamaica's 110m hurdles champion Omar McLeod, who ran the first leg for the quartet, summed up the feeling of everyone.

"Usain Bolt's name will always live on," he said.

But another teammate, Yohan Blake, who won Olympic relay gold with Bolt in 2012 and 2016, slammed organizers for the delay in starting the race because of medal ceremonies.

"Usain was really cold. In fact Usain said to me, 'Yohan, I think this is crazy,'" he said.

(Source: CNN)

Edris ends Farah's invincibility in final race

Mo Farah's aura of invincibility after six years of unrelenting success was finally cracked in his very last major track race on Saturday as he lost his world 5,000 meters title to Ethiopia's Muktar Edris.

Seeking a fitting end to his matchless long-distance racing career before moving to marathon running, the 34-year-old Briton's bid for a fifth straight global 10,000/5,000m double was scuppered as he had to settle for the silver.

Yet even in defeat, Farah demonstrated his champion's spirit as he fought back in the dying meters when it looked as if he would be shut out of the medals completely.

In a thrilling finale featuring four athletes careering towards the line, Farah snatched back second place behind Edris, who clocked 13 minutes 32.79 seconds after a searing final lap of 52.6 seconds.

"I gave it all but I had nothing left at the end," a crestfallen and emotional Farah said.

"It's been a long journey but it's been incredible. It doesn't quite sink in until you compete here and cross the line - I had a couple of minutes to myself - that this is it."

"To be honest with you it takes so much out of me. It's not an excuse, but it took a lot more out of me than I realized."

It was a glorious win for 23-year-old Ethiopian Edris, the



fastest man in the world this year, who had lost all his five previous meetings with Farah.

Yet just like Usain Bolt in the 100 meters the previous weekend, it did look a race too far for the weary Briton.

To rub in his victory after years of the Ethiopians being tormented by Farah's brilliance, Edris even gave an impression of his rival's famed "Mobot" celebration as he crossed the line.

"I was highly prepared for this race and I knew I was going to beat Mo Farah," Edris said.

"After the 10km he was maybe tired so he did not have enough for the last kick. I was stronger."

"I didn't have much support but we did it. I did the Mobot out of respect as well for him."

Behind Edris, Farah dug deep to battle back from fourth to second when space opened up on the inside over the last few meters to take silver in 13:33.22.

LATE BURST

Kenyan-born American Paul Chelimo claimed bronze in 13:33.30 while Farah's late burst also consigned another Ethiopian Yomif Kejelcha to fourth place in 13:33.51.

It was a poignant sight after so many Farah celebrations down the years to see him lying on his back, exhausted and forlorn with his arm draped across his face, but his rivals were not about to let the moment pass without celebrating him.

Edris hauled Farah to his feet as his other rivals all wanted to give him a hug of consolation.

It was the great man's first defeat in a major championship race since the 2011 world 10,000 meters final when he also won silver - and, once again, it took dazzling speed to beat him over the last lap.

(Source: Reuters)

Gerrard: Barca tell Coutinho 'now or never'

Steven Gerrard believes Barcelona are putting pressure on Philippe Coutinho to force his way out of Liverpool this summer but told BT Sport that "the least he can do is give the club another year."

Barcelona have targeted Coutinho as they seek to strengthen their squad following Neymar's €222 million move to Paris Saint-Germain, but Liverpool owners Fenway Sports Group (FSG) issued a statement on Friday insisting the 25-year-old will not be sold.

The Brazil international responded by issuing a transfer request but manager Jurgen Klopp said the timing meant the move was out of the question.

Club legend Gerrard, who now works as an academy coach at Anfield, said in his role as a pundit for BT: "The problem here are Barcelona, because they will be saying to Coutinho's representatives: 'It's now or never. If he doesn't come now, we're never coming back for him ever again.' So they're piling the pressure on and that's why Philippe's reacted."

"This kid who's come from South America has always had a dream of playing for Barcelona, and he's panicking thinking that if he doesn't do it now it'll never happen again."

Asked if he had sympathy for Coutinho, Gerrard said: "A little bit. Of course. I know the kid, I know he's not a bad person, I know he doesn't want to cause a war to come out. But at the end of the day he's just signed a five-year deal, the club have



been superb to him and made him the player he is.

"You remember he was struggling at Inter Milan. We gave him the chance, we built this player up. The least he can do is give the club another year."

Luis Suarez, who joined Barcelona in 2014, remained at Liverpool for a further year despite having been tempted by a move to Arsenal when they attempted to trigger his buyout clause in 2013.

Asked how he convinced Suarez to give Liverpool one more year, Gerrard said: "It was slightly different. Obviously Arsenal were calling. I'm not sure Barcelona were calling for Suarez at that time."

(Source: Soccernet)

Chelsea's squad crisis is already threatening to derail title defence

At Cobham on Friday, Antonio Conte was asked whether the Premier League would have to wait until Eden Hazard and Tiemoué Bakayoko returned to full fitness to see the real Chelsea. "I hope and want to see the real Chelsea tomorrow," he replied. "Now the season is starting and we must be ready, even with many players missing."

The real Chelsea took 45 minutes to appear at Stamford Bridge on Saturday, but the Premier League doesn't wait for any team, champions or not. Burnley's second away win in two years — and particularly the manner in which it played out — has put Conte's men in a significant hole as they head into a run of fixtures that would test them at the best of times.

These, quite clearly, are not the best of times.

Conte angrily batted away the suggestion that his youthful squad selection — 20-year-old Jeremie Boga making his Premier League debut and a bench including six outfielders with an average age of just under 21 — was a message to the Chelsea board about the need for new signings, and in

reality he could have done little else. The only experienced players available and omitted from the 18-man squad were third-choice goalkeeper Eduardo, the exiled Diego Costa and Loic Remy, who is waiting to be sold.

Hazard and Bakayoko do not yet have return dates and Pedro is battling to overcome an ankle knock in time to face Tottenham at Wembley next Sunday. Victor Moses returns from suspension but Gary Cahill and Cesc Fabregas are out after seeing red against Burnley. As things stand, Conte will have to pick one of the most makeshift teams of his tenure, backed up largely by players that Danny Rose would have to Google.

Conte, pressed in his post-match news conference on how Chelsea can escape their narrative of summer frustration and misfortune, returned to his trusted mantra. "Now we have to work," he insisted. "We must know this. There is only this way for me and my players." They know the other way from here all too well at Stamford Bridge, and there is no desire to repeat it.

(Source: Fox Sports)

First Announcement

N.I.O.C
1396.2083

Public Calls For Quality Evaluating Of Tender(First Publish/Seconed Publish)

One-Stage(compressed)						
TENDER GUARANTEE		ESTIMATED VALUE (Rial)	Subject of Tender	Tenders Portal Reg. No.	TENDER NO. / INDENT NO	No
Euro	Rial					
17, 857	625 ,000,000	12,500,000,000	HIGH PRESSURE HOSE FOR MUD DRILLING 5000 PSI 2 ID/ 30FEET	1/495/578	Tender No.:FP/11-96/026 Indent No.: 01-22-9545308	1

Brief discription of subject:
National Iranian Drilling Company(NIDC) address pasdaran Blev., Airport Saqare, Ahvaz, Iran hereby intends to purchase its requirements from qualified and interested tenderers through two-stage public tender (semi-pressd) upon following terms and conditions:

A) Qualitative evaluation of tenderer:
The evaluation is based on article (J) implementing regulations of the law of tenders and also carried out base on worksheets qualitative evaluation inquiry in the tender documents. Minimum acceptable point of quality is 60.

B) Preparation of tender documents:
Purchasing of documents:
In order to receive the tender documents, 510,000 Rials should be paid to SIBA account number 2174652205004 of NIDC in Bank Meli Iran and providing the original deposit receipt.
Notice: According to N.I.D.C technical and commercial committee rule, the limitation for job referrals in procurment field is four active and in process contract.
Receiving of documents:
Tenderers must be obtain the quality evaluation documents along with tender documents maximum ten days after the date of second publication in person at the following address: Hall No.:113, 1thfloor, Foreign Procurement Dept., National Iranian Drilling Company, Airport square, Ahvaz, IRAN
Notice: Only the real or legal persons who apply to purchase and recieve tender ducments from foreign procurment department in due date and participates in tenderwill be known as tenderer from tender committee.

C) Delivery of call quality evaluating:
Tenderers shall submit the completed documents including qualification worksheets in form of software in cd and documentary within 14 days from last day of document received deadline to the following address: Hall No.:107, 1thfloor ,Tender Committee, Building operations, National Iranian Drilling Company, Airport square, Ahvaz, IRAN.

D) Tender Guarantee:
Type of guarantee:
A)Bank guarantees or guarantees issued by non-bank institutions that have activites licensed by the Central Bank of the Islamic Republic of Iran.
B) The original cash deposit receipt paid to National Iranain Drilling Company.
Duration of credit guarantee & quotation:
This duration should be valid for 90 days and extendable maximum For one time in initial credit amount.
More on this & other tenders is accessible by click on. WWW.NIDC.IR
Foreign Procurement Dept
National Iranian Drilling Company

تهران تایمز : نوبت اول ۹۶/۵/۲۳ نوبت دوم ۹۶/۵/۲۴

Iran book ticket for 2018 Men's World Championships

S P O R T S Iran, the only Asian team competing in the FIVB World League Group 1 this season, qualified for the 2018 FIVB Men's World Championships.

On Sunday, the Iranian team eased past Kazakhstan 3-0 (25-18, 25-17, 25-16) in Pool A at the 6,000-seater Rezazadeh Stadium.

Iran have already defeated South Korea and China in the five-day tournament.

Igor Kolakovic's men have been scheduled to meet Qatar on Monday.

Earlier in the day, China also defeated South Korea 3-0 to book a place at the 2018 FIVB Men's World Championships.

Japan and Australia have previously qualified for the prestigious competition as Pool B's top finishers.

The 2018 FIVB Volleyball Men's World Championship will be jointly hosted by Italy and Bulgaria.

Hosts Italy and Bulgaria and defending champions Poland have automatically qualified for the next year's World Championship. France, the Netherlands, Slovenia, Russia, Serbia, Finland, and Belgium from Europe plus Japan and Australia from Asia have also booked their tickets through continental qualifiers.



Hamed Haddadi the best playmaker in Asia Cup: FIBA



The official website of FIBA, the International Basketball Federation, has praised the Iranian center.

Centers are not usually known for their passing and playmaking, but Iran's Hamed Haddadi has defied that in the Asia Cup 2017.

Haddadi, the 2.18m center for Team Melli, currently leads the entire tournament in assists, handing out an eye-popping 8.5 per game. That's in addition to scoring 16.0 points, grabbing 8.5 rebounds and blocking 1.5 shots per contest as well.

Haddadi seems to have really

mastered the art of attracting opposing defenders and finding his open teammates in spots where they can easily score. Sure, he may have lost a lot of quickness and explosiveness, but Haddadi's high basketball IQ comes to the fore when maximizes his court vision and puts the ball in the hands of his teammates who are scoring position.

This just makes things much more difficult for Iran's opponents, who know have to craft a game plan around not just stopping Haddadi's scoring but his playmaking as well.

(Source: FIBA)

€222m for Neymar? He's not that good! - Bayern president Hoeness



Neymar is not worth the €222million Paris Saint-Germain paid Barcelona, according to Bayern Munich president Uli Hoeness.

PSG stumped up a world-record fee to prise the Brazilian away from Camp Nou, and prior to the completion of the transfer Hoeness branded the Ligue 1 club's willingness to part with such an astronomical sum as "a sign of weakness".

Neymar won LaLiga twice, struck the final goal in Barca's 2015 Champions League final triumph and has scored 52 goals for Brazil.

However, Hoeness is unsure whether the 25-year-old - who could make his

PSG debut against Guingamp on Sunday - was worth such a significant outlay.

"€222million? I don't consider Neymar that good," Hoeness said on Sky.

Hoeness was also critical of Neymar's Brazil team-mate Douglas Costa.

Costa swapped Bayern for Juventus in a loan move that could become permanent if an option in his contract is triggered, with Hoeness stating he had not earned the new deal he wanted at the Allianz Arena.

"Costa wanted more money after only a little time, despite not performing well at all," he said.

(Source: Goal)

Barcelona set to sign Paulinho

Paulinho is set to fly to Barcelona on Sunday from Chinese Super League leaders Guangzhou Evergrande after they activated the former Tottenham midfielder's €40 million buyout clause, according to multiple reports in China.

Chinese media reported on Saturday evening that the 29-year-old Brazilian would travel to Spain to complete the move after Barcelona triggered his release. Ernesto Valverde's side are looking to bolster their squad following the world record €222m sale of Neymar to Paris Saint-Germain last week.

Paulinho has been linked with a move to Barcelona throughout the summer but Evergrande chairman Xu Jiayin had previously stated he would not be allowed to leave before the end of the season due to the cost associated in replacing him.

The ex-Corinthians star has been a key figure for Evergrande this season, with his goals vital in Luiz Felipe Scolari's side retaining their position at the top of the league as well as progressing to the quarterfinals of the Asian Champions League.

The move could prove problematic for Guangzhou, who lead the league by five points from Shanghai SIPG. With the Chinese Super League's transfer window closing in mid-July, they will be unable to sign a replacement.

(Source: Soccer.net)



Iran to investigate issue of soccer players playing against Israel

Iran Football Federation will investigate the issue of two national team players who played in a match for their Greek club against an Israeli side and will decide about it, sport minister said on Sunday.

Iranian Minister of Sports and Youth Affairs Masoud Soltanifar made the remarks in reaction to global soccer body FIFA which has asked for further information on the issue. In a statement released by Reuters on Saturday, FIFA has asked Iran to clarify on the status of Masoud Shojaie and Ehsan Hajjafi who played for Panionios against Zionist regime's Maccabi Tel Aviv one week ago in a Europe League match.

"We are currently monitoring the matter and will request additional information from the Iran Football Federation," said a FIFA spokesperson in an e-mailed statement. "We have no further comment for the time being."

Mohammad Reza Davarzani an official in Iran's Sport Ministry had previously condemned the act of Iranian football players, noting that "They have crossed the red lines."

FIFA rules prohibits interference of politics in sport and the national teams and the clubs of any country that breach this rule will be deprived of participating in the international games.

Iran has been qualified for World Cup 2018 to be held in Russia.

(Source: Irna)

Race walker Diniz becomes oldest world champion at 39

LONDON (Reuters) — Yohann Diniz produced an astonishing solo tour de force to become the oldest man ever to become a world athletics champion at the age of 39 as he won the 50 kilometer walk title on Sunday.

The French world record holder, one of the great figures of race walking, produced the second fastest walk in history, 3 hours 33 minutes 12 seconds -- a time only he has bettered -- with one of the performances of the entire World Championships.

Diniz was so dominant en route to his long-awaited first global title that he lapped nearly all the 43-strong field over the 2km looped circuit on The Mall, finishing less than a minute adrift of his three-year-old world record of 3:32:33.

He was even able to take a swift comfort break when leading in the first 15 minutes before rejoining the race and destroying his opponents over the 25 laps between Admiralty Arch and Buckingham Palace.

A great showman, father of two Diniz was even able to smile and wave to the crowds lining the course well before the finish as he landed a third gold of the championships for France.

He blew kisses towards Buckingham Palace on the last circuit, turning it into a glorified lap of honor, and approached the line while making a scarf out of a tricolor he had grabbed from the crowd before then hoisting it aloft to celebrate his new championship record.

He had only one moment of concern when he received a red card for an infringement at about the 20km mark. "I started having doubts but in training, we have been doing lots of changes of rhythms, so I just kept going."

"I got a card too and I thought 'I just must not mess this up.' I just concentrated completely on my technique."

"Last night I kept away from watching the athletics on TV because I did not want to get too excited. I went to bed at nine because I knew it was going to be my day!"

His eight-minute gap over his two distant Japanese pursuers, silver medalist Hirooki Arai (3:41:17) and bronze medalist Kai Kobayashi (3:41:19), was by far the biggest ever recorded in the championships.

Diniz became the oldest male world champion in any event, surpassing another walker, 37-year-old Ve-



niamin Soldatenko. The Soviet athlete won a specially-staged 50km event in Malmo in 1976, seven years before Helsinki staged the first global championships.

Belarussian Ellina Zvereva holds the overall record of being the oldest world champion, having won the women's discus in 2001 at the age of 40.

Diniz's triumph, the first ever in race walking by a Frenchman, came a year after his heartbreak in the Rio Olympic final when he led by nearly two minutes before he collapsed at 37km with heatstroke, dehydration and gastric problems.

He was then hailed as a hero as he got up, insisted on continuing and, incredibly, finished the race in eighth place.

When Diniz competed on this same course on the Mall during the 2012 Olympics, he had been forced to pull out during the race.

His familiar all-or-nothing approach had seen the three-time European champion Diniz miss out in five previous global championships but for a man famed for being a wine-making expert, this was a champagne moment.

Would it not perhaps be the perfect time to retire on a high, he was asked. "It is a lovely Sunday afternoon. I know you should never take any decision when you are hot," he smiled.

"I am still missing one title and that is the Olympic one. It would be a nice way to finish in Tokyo."



N.I.O.C
1396.2154



National Iranian Drilling Company

Public Calls For Quality Evaluating Of Tender(First Publish/Seconded Publish)

One-Stage(compresed)

TENDER GUARANTEE		ESTIMATED VALUE (Rial)	Subject of Tender	Tenders Portal Reg. No.	TENDER NO. / INDENT NO	No
Euro	Rial					
8, 100	2,803,000,000	74,118,476,858	PARTS FOR HOOK VARCO BJ-5500	1/496/227	Tender No.:FP/17-96/031 Indent No.: 48-22-9622040	1
5, 390	188,700,000	3,773,957,969	PARTS FOR KELLY SPINER FOSTER77	1/496/229	Tender No.:FP/17-96/032 Indent No.: 48-22-9622042	2

Brief discription of subject:
National Iranian Drilling Company(NIDC) address pasdaran Blev., Airport Saqare, Ahvaz, Iran hereby intends to purchase its requirements from qualified and interested tenderers through one-stage public tender (compressed) upon following terms and conditions:

A) Qualitative evaluation of tenderer:
The evaluation is based on article (J) implementing regulations of the law of tenders and also carried out base on worksheets qualitative evaluation inquiry in the tender documents. Minimum acceptable point of quality is 60.

B) Preparation of tender documents:
Purchasing of documents:
In order to receive the tender documents, **510,000 Rials** should be paid to SIBA account number 2174652205004 of NIDC in Bank Meli Iran and providing the original deposit receipt.
Notice: According to N.I.D.C technical and commercial committee rule, the limitation for job referrals in procurement field is four active and in process contract.
Receiving of documents:
Tenderers must be obtain the quality evaluation documents along with tender documents maximum ten days after the date of second publication in person at the following address: Hall No.:113, 1thfloor, Foreign Procurement Dept., National Iranian Drilling Company, Airport square, Ahvaz, IRAN
Notice: Only the real or legal persons who apply to purchase and recieve tender ducments from foreign procurement department in due date and participates in tenderwill be known as tenderer from tender committee.

C) Delivery of envelopes of bids and call quality evaluating:
Tenderers shall submit simultaneously envelopes of bids including bank guarantees (a)financial offer (c) and stamped and signed of tender documents (b) along with qualification worksheets in form of software in cd and documentary within 40 days from last day of document received deadline to the following address: Hall No.:107, 1thfloor ,Tender Committee, Building operations, National Iranian Drilling Company, Airport square, Ahvaz, IRAN.

D) Tender Guarantee:
Type of guarantee:
A)Bank guarantees or guarantees issued by non-bank institutions that have activites licensed by the Central Bank of the Islamic Republic of Iran.
B) The original cash deposit receipt paid to National Iranain Drilling Company.
Duration of credit guarantee & quotation:
This duration should be valid for 90 days and extendable maximum For one time in initial credit amount.
More on this & other tenders is accessible by click on. WWW.NIDC.IR
Foreign Procurement Dept
National Iranian Drilling Company

تهران تایمز : نوبت اول ۹۶/۵/۲۳ نوبت دوم ۹۶/۵/۲۴

INTERNATIONAL DAILY
www.tehrantimes.com

Managing Director: Ali Asgari
Editor-in-Chief: Hassan Lasjerdi

Editorial Dept.: Fax: (+98 21) 88808214 — 88808895
editor@tehrantimes.com
Switchboard Operator: Tel: (+98 21) 43051000
Advertisements Dept.: Telefax: (+98 21) 43051450
Public Relations Office: Tel: (+98 21) 88805807
Subscription & Distribution Dept.: Tel: (+98 21) 43051603
www.eshterak.ir Distributor: Padideh Novin Co.
Tel: 88911433
Webmaster: webmaster@tehrantimes.com
Printed at: Kayhan - ISSN: 1017-94

No. 18, Bimeh Alley, Nejatollahi St., Tehran, Iran
P.O. Box: 14155-4843
Zip Code: 1599814713



Calcutta festival honors Iranian films

A R T TEHRAN — Four Iranian films won awards at the July edition of the Calcutta International Cult Film Festival (CICFF), a monthly live screening film festival in India, the organizers announced on Thursday.



"Cold Breath" directed by Abbas Raziji won the Best Narrative Feature Award, while "Golden Time" by Atefeh Rahmani received the Best Women's Film Award.

"A Share of Share" by Kaveh Jahed won the Outstanding Achievement Award for One-Minute Films and "Not Acceptable" by Saman Haqiqvand was named Best Web and New Media Film.

The CICFF is a member of the British Film Institute in London and the Film Society of Lincoln Center in New York.

Movies from Iran to go on screen at Animaze festival

A R T TEHRAN — A lineup of six Iranian animations will go on screen at the various sections of the Montreal International Animation Film Festival - Animaze, which will open in the Canadian city on Thursday.



The lineup includes "Ascribed Achievements" by Samaneh Shojaei, "The Servant" by Farnush Abedi, "Roo-hangiz" by Elmira Baqerzadeh and "Icky" by Parastu Kardgar.

"Maned and Macho" by Sadeq Asadi and "Release from Heaven" by Ali Nuri-Oskui will also go on screen at the festival, which will run until August 21.

"Ascribed Achievements" will also compete in the 13th Busho-Budapest Short Film Festival, which will be held in the Hungarian capital of Budapest from August 29 to September 3.

After 30 years, museum gets stolen piece by modern master

PHOENIX (AP) — More than three decades after thieves made off with a valuable painting from the University Of Arizona Museum Of Art, officials say they have recovered the long sought piece from an antique dealer in New Mexico.

Curators at the museum that was home to Willem de Kooning's "Woman-Ochre" spent years hoping to get it back after two people stole the painting the day after Thanksgiving in 1985.

That dream finally came true when furniture and antique dealer David Van Auker called the museum from Silver City, New Mexico. Marketing Manager Gina Compitello-Moore said Auker bought the painting at an estate sale and later began researching it when he read an article about the heist that depicted an identical looking piece.

"When I got the phone call, this is literally the phone call I've been dreaming of - is somebody calling my phone and saying I think I have your stolen painting and that's what he said," museum curator Olivia Miller said.

Miller said it really stood out to her when Van Auker mentioned damaging lines across the canvas that made it look as if it had been rolled up. Miller said a former museum curator was in utter disbelief and elated when she told her the painting was recovered.

The oil painting by the Dutch-American abstract expressionist is one in an iconic series by de Kooning that explores the figure of a woman. The piece features de Kooning's signature broad paint strokes, depicting various colors across the female body.

"The Salesman" crowned best film at Hafez Awards

I → In addition, Fatemeh Motamed-Arya for her role in "Abajan" and Elnaz Shakerdost for her role in "Mobarak" won the awards for best actress.

Director/actor Reza Attaran won the award for best screenwriter for a script for his comedy film "Dracula". Another award in this category went to director/writer Narges Abyar for her drama "Breath".

Mohammad-Ali Keshavarz, the 87-year-old star of many memorable movies such as director Ali Hatami's "Mother", received a lifetime achievement award from his lifelong friend and colleague Jamshid Mashayekhi.

Actor Mohammadreza Golzar received the special jury award for his role in Iranian director Qorban Mohammadpur's melodrama "Salam Mumbai", which was shot in India in 2015.

"The Invincible Diplomacy of Mr. Naderi", a film directed by Behdash Sanaei about a man named Naderi who wants to act a mediator between Iran and the United States, was selected as best documentary.

Director Reza Dormishian won the Abbas Kiarostami Award, which was launched by the organizers last year in honor of the world renowned filmmaker. The award is presented to an innovative filmmaker.

In the TV production category, "The Licentiate" was picked as best series and co-writers Soroush Sehat and Iman Safai also received the best screenwriter award for the serial.

The best host award went to Ehsan



Actor Mohammad-Ali Keshavarz (C) speaks after being honored for his lifetime achievements during the 17th Hafez Awards at the Grand Hall of the Interior Ministry in Tehran on August 12, 2017. Host Mehran Modiri (R) and actor Jamshid Mashayekhi (L) are also seen in the photo. (Honaronline)

Alikhani for his talk show "Mahe Asal", which is being broadcast every year dur-

ing the holy month of Ramadan.

He dedicated his award to the family of

Mohsen Hojaji, an Iranian soldier who was killed by Daesh forces in Syria last week.

Iranian artists invited to Global Nomadic Art Project in Germany

A R T TEHRAN — Two Iranian artists Mahdih Dehqani and Atefeh Khaas have been invited to attend the Global Nomadic Art Project (GNAP), which is scheduled to take place in Darmstadt, Germany running from August 19 to September 3.

Dehaqani is a graduate of graphic design and Khaas has studied paintings.

A group of 12 German artists and 13 artists from Hungary, India, Iran, Lithuania, South Korea, South Africa and Sweden will work on the project.

The subject of the GNAP is "Urban Nature Art" and will be carried out in a geologically and historically rich environment of UNESCO Global Geopark, which provides sites in hills and at rivers. GNAP has announced on its website.

The artists will create ephemeral works of art during 16 workshops. Every day, they will be brought to a different site, work there, document their work and leave the place to nature again.

The exhibition of "Urban Nature Art" will run for one month at the site and on the open-air ground of Internationales Waldkunstzentrum (WZ). Part of it will also be shown in the visitor centers of UNESCO Geopark.

The Global Nomadic Art Project has been founded by artists' association Yattoo in South Korea together with 20 international nature art curators. So far,



This picture shows an artwork by Atefeh Khaas.

the project has been carried out in places in Asia, Africa, and the Middle East.

The coastal village of Salakh on the Persian Gulf island of Qeshm hosted the event in 2016.

Germany, France, Lithuania, Bulgaria, Romania, Hungary and Turkey are the hosts in 2017, and the project will go to America in 2018.

All outdoor activities will be documented by film and photo so they can be exhibited in galleries and museums. Finally, everything will be summarized in documentary films.

Bruno Mars donates \$1m from concert to flint water crisis

NEW YORK (AP) — Bruno Mars said Saturday he is donating \$1 million from his Michigan concert to aid those affected by the Flint water crisis.

The Grammy-winning star told the audience at his show in Auburn Hills, about 30 miles (48 kilometers) from Detroit, that he and tour promoter Live Nation are redirecting funds from the show to the charity The Community Foundation of Greater Flint.



Bruno Mars urged people not to forget those affected by the water crisis

In 2014, Flint switched water sources and failed to add corrosion-reducing phosphates, allowing lead from old pipes to leach into the water. Elevated levels of lead, a neurotoxin, were detected in children, and 12 people died in a Legionnaires' disease outbreak that experts suspect was linked to the improperly treated water.

"I'm very thankful to the Michigan audience for joining me in supporting this

cause," Mars said in a statement. "Ongoing challenges remain years later for Flint residents, and it's important that we don't forget our brothers and sisters affected by this disaster."

Mars, who was born and raised in Hawaii, performed at the Palace of Auburn Hills during his sold-out 24K Magic World Tour. His latest album, "24K Magic", recently achieved double platinum status.

Art, or just a bunch of er, balloons?

LONDON (Reuters) — Art is well known for its power to move people, but a new installation in London can move itself - it comprises a series of autonomous floating spheres, that interact with visitors and the space on their own.

The installation -- "+/- Human" in London's Roundhouse -- is a collaboration between choreographer Wayne McGregor and art group Random International.

Several drones -- floating balloons with small propeller motors attached -- are fitted with a motion tracking system to allows them to identify and interact with visitors.

"We wanted to make a piece which

was a piece related to autonomous objects and live bodies", McGregor told Reuters.

"I love that relationship between body and machine, I love that between intelligences, I love it between this notion of what is autonomy and how wide can we have a sense of autonomy nowadays," he added.

The spheres' motion tracking system looks for a person to interact with, and allows the drone to find a pathway to reach that person. If the person moves, it reacts, and will interact with them until deciding to move on.

"In basic terms, it really is a kind of attraction and repulsion," McGregor said.

Wild brass bands festival kicks off in Serbia

GUCA, Serbia (Reuters) — The 57h Guca Brass Band Festival, Serbia's liveliest traditional music event, has attracted tens of thousands of people crowding the streets and savoring the trumpet beat.

Guca, a normally sleepy town with only 3,700 people in the rolling hills of southwestern Serbia, is hosting the country's biggest party, with 50 brass bands competing for the coveted Golden Trumpet.

Launched in 1961 with just four bands and only 2,500 visitors, Guca has since received more than 15 million people.

The "Dragacevo Trumpeters Assembly", as the festival is officially called, now

lures not only Serbians but tourists from around the world.

"One Serbian girl in Germany told me about it ... and now I'm here, it's great, I love it," said Maria, a Bulgarian tourist in her 20s.

The music has a long tradition in Serbia - it goes back to a royal decree establishing a military brass band in 1831.

The bands, those competing for the prize and those weaving through dozens of tents make good money from tips.

In an attempt to avoid the serious road accidents which have marred the festival in the past, police have ordered all drivers along the two roads leading in and out of Guca to take a Breathalyzer test.